

A	B	C1	C2	C3	D
1	M245-3051	340	280	22	1/1
2	M245-4051	1510	396	16	1/1

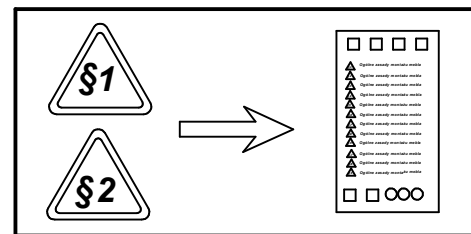

6x Ø5x11 mm e4	2x Ø7x60 mm e8	1x Ø8x30 mm f1	3x g2	1x Ø6-L-388 mm g65\2	4x g64
2x Ø10; L=64 mm g65\3	1x Ø10; L=212 mm g65\4	2x M4x28 mm j11	5x M4x22 mm j30	1x z1	1x Ø14x0,5 mm s59

3x Ø10x50 mm f35	3x Ø6x60 mm p75
-------------------------------	------------------------------

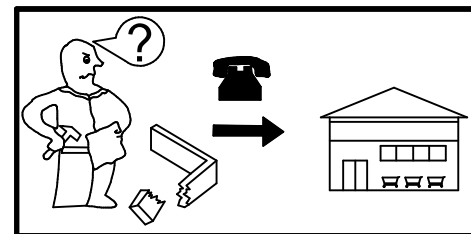
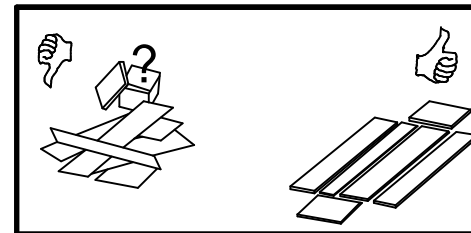
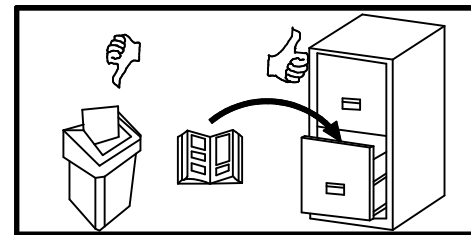
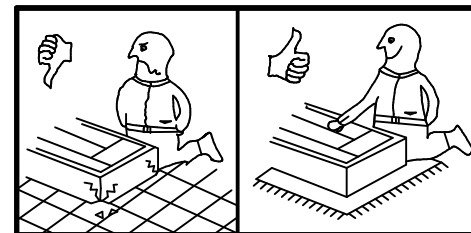
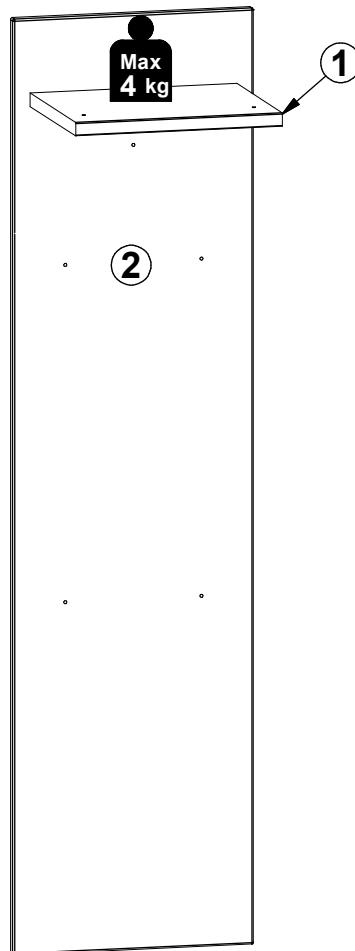
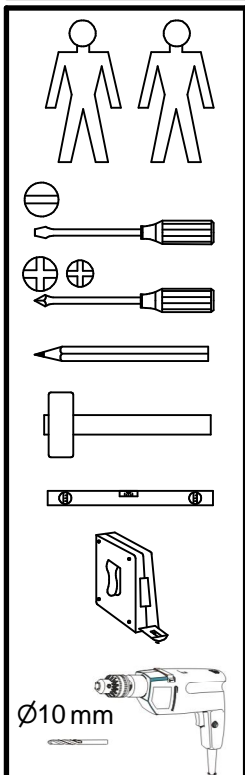
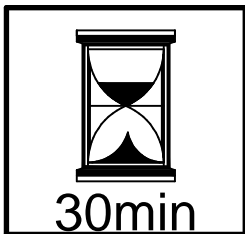
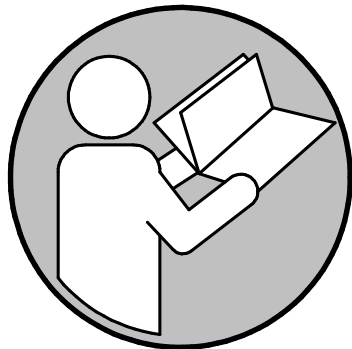
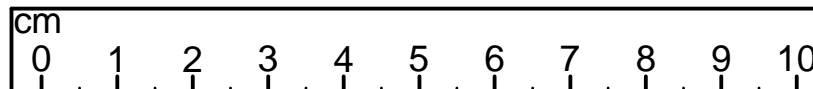

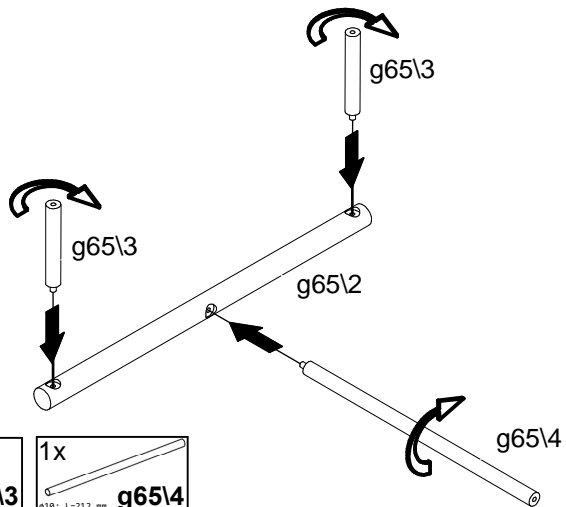
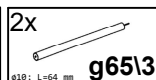
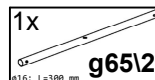
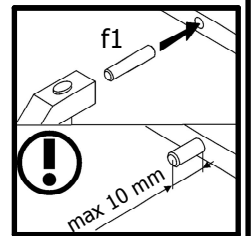
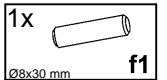
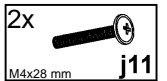
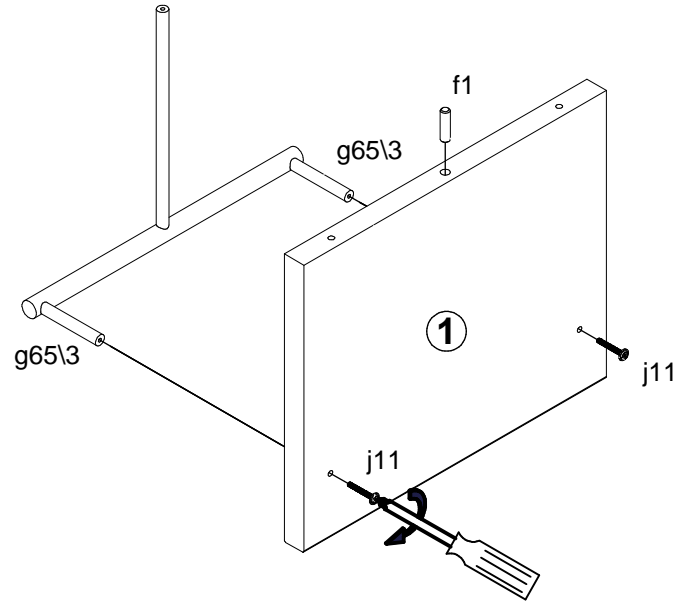
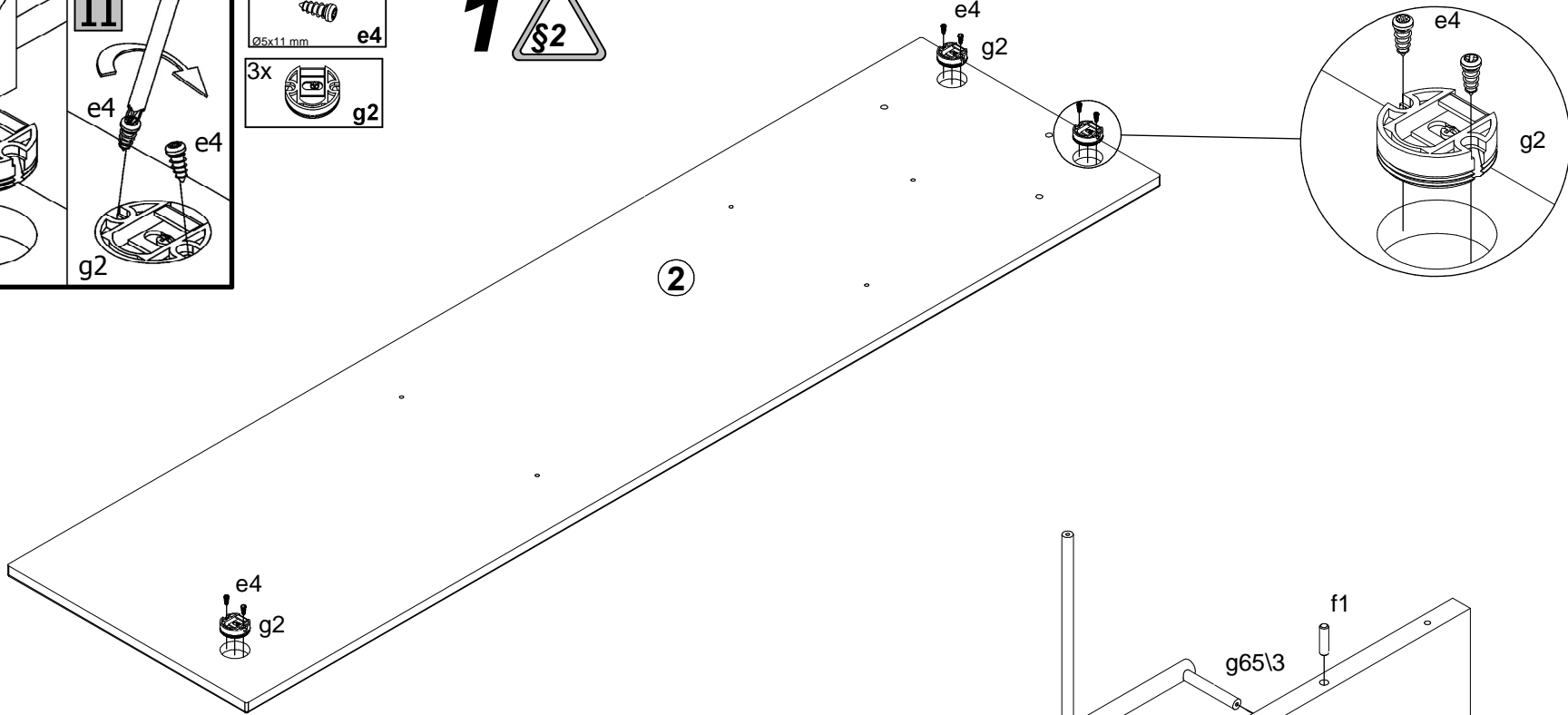
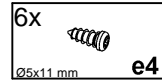
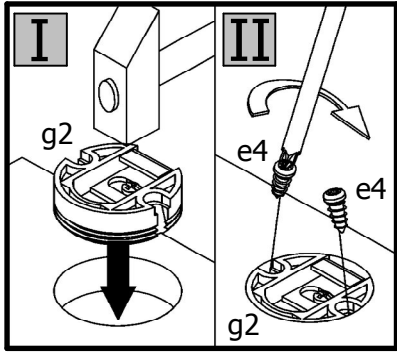



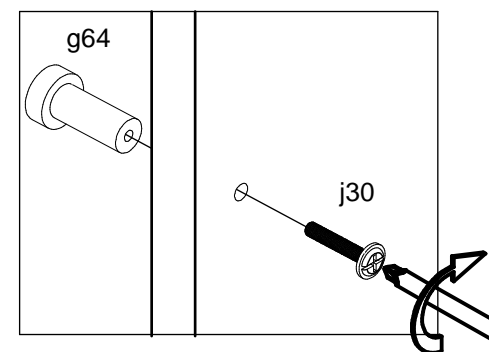
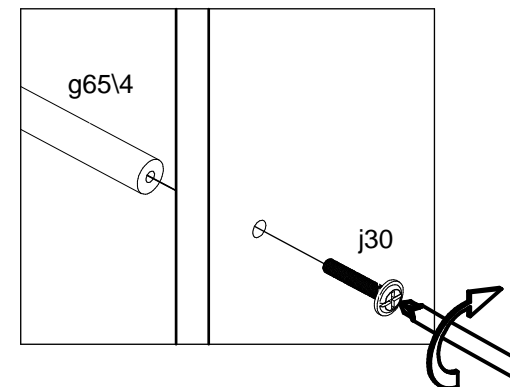
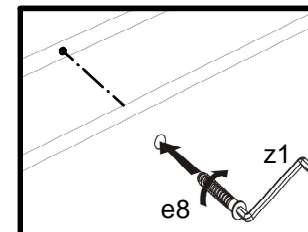
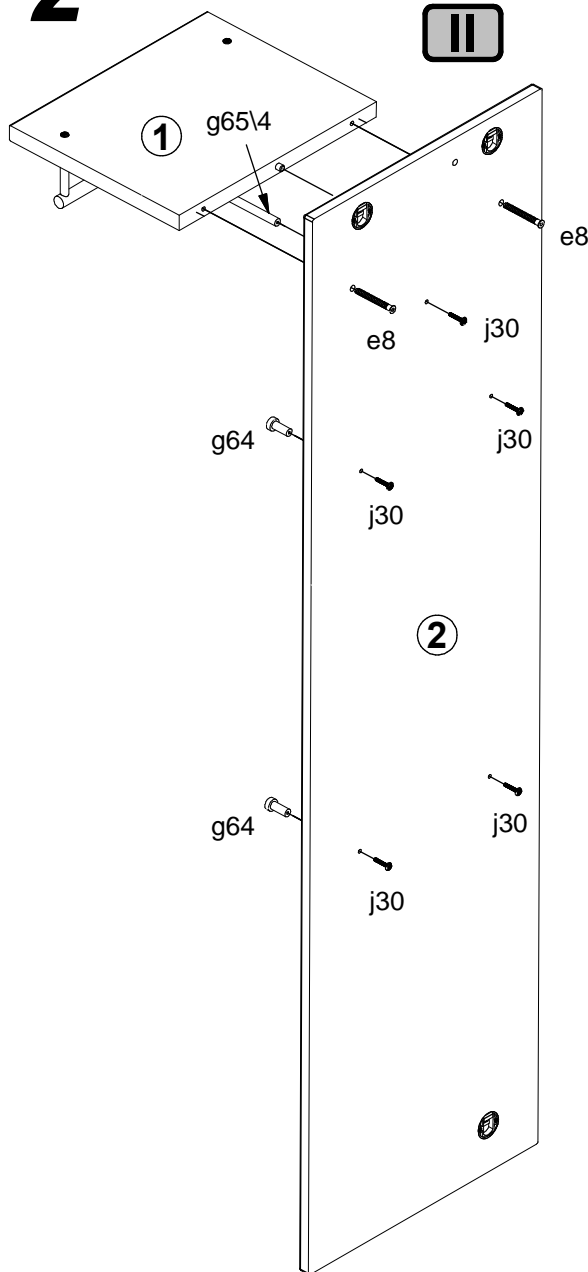
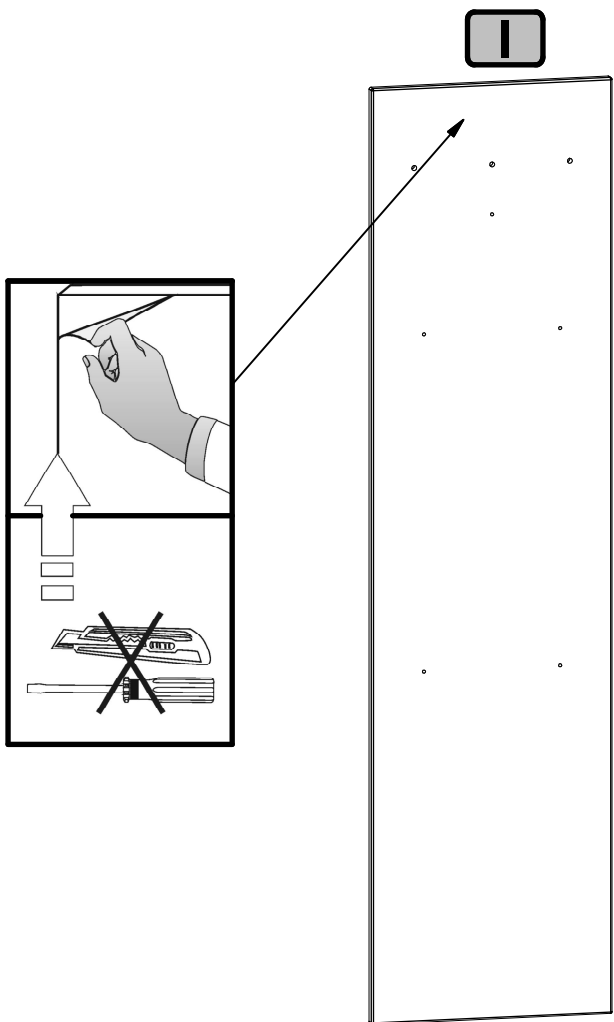

2

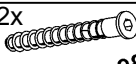

- 4x  g64
- 2x  e8
Ø7x60 mm
- 5x  j30
M4x22 mm

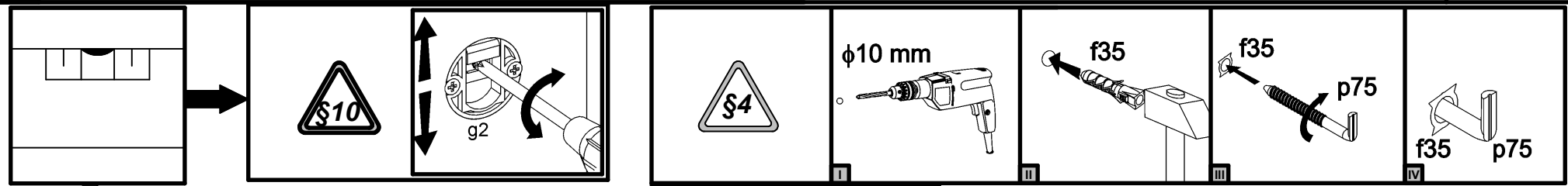

3

