

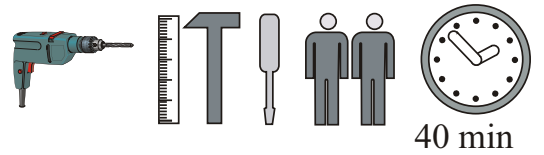

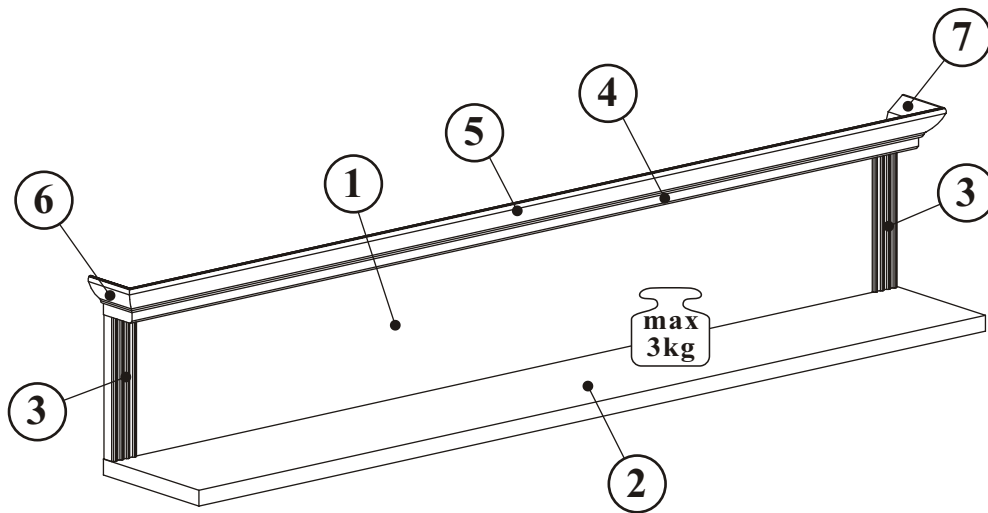

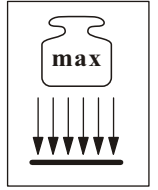





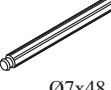

# JASMIN 10G9\_40

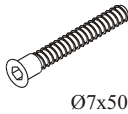

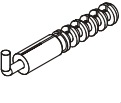
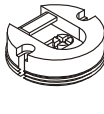
| NO | Dim.   |     | Col.-No | Qty |
|----|--------|-----|---------|-----|
| 1  | 1272   | 200 | 1       | 1   |
| 2  | 1360   | 200 | 1       | 1   |
| 3  | 200    | 43  | 1       | 2   |
| 4  | 1360   | 60  | 1       | 1   |
| 5  | 1412,7 | 67  | 1       | 1   |
| 6  | 86,4   | 67  | 1       | 1   |
| 7  | 86,4   | 67  | 1       | 1   |

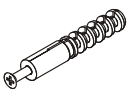
|  |  |   |   |  |  |
|--|--|---|---|--|--|
| A1<br>x8<br><br>ø8x36   | A3<br>x4<br><br>ø8x47 | B5<br>x4<br><br>ø15x12 | G5<br>x4<br>   | B9<br>x2<br><br>ø7x48       | D9<br>x8<br><br>USØ3x20 |
| B11<br>x12<br><br>ø7x50 | G4<br>x12<br>         | KR2<br>x3<br>          | ZM1<br>x3<br> | D20<br>x6<br><br>ESØ6,3x9,5 | G2<br>X1<br>            |
| KR1<br>x1<br>           | G12<br>x1<br><br>Ø14  |   |   |  |  |

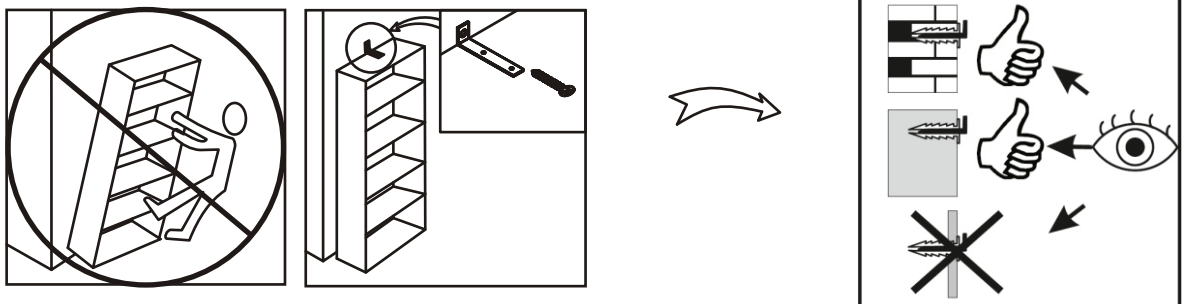
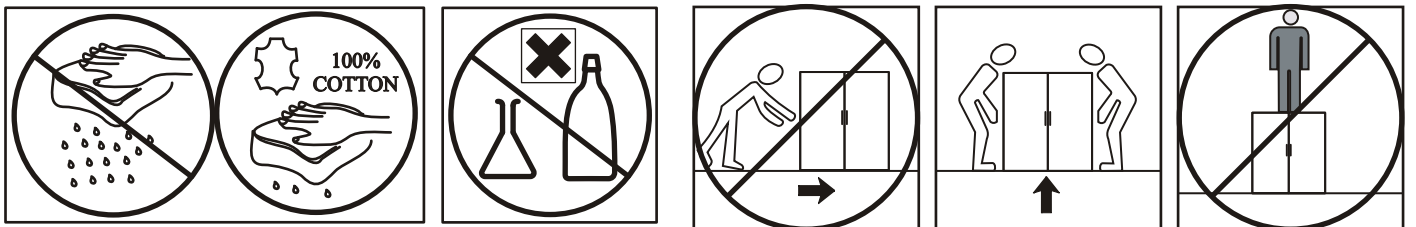
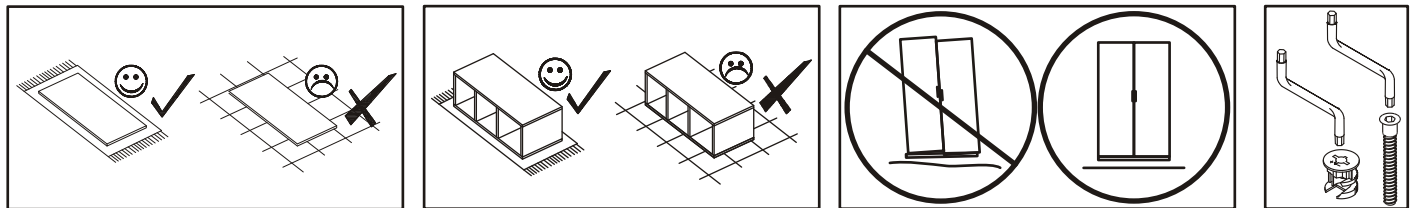
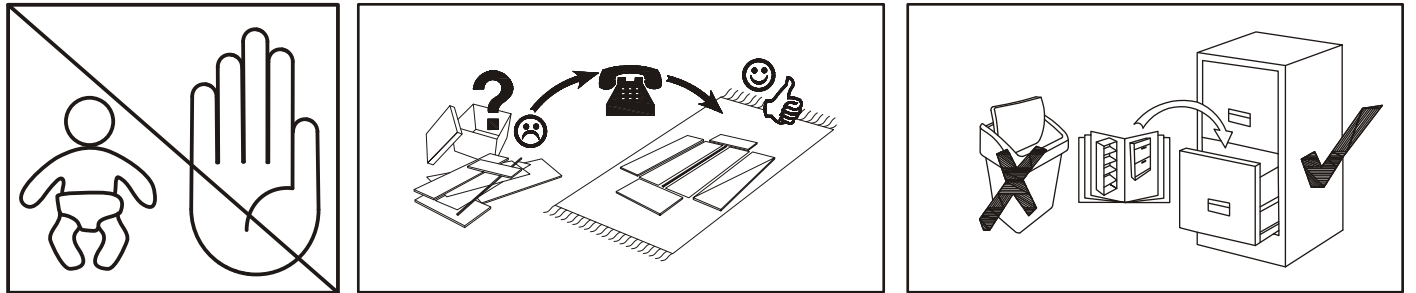
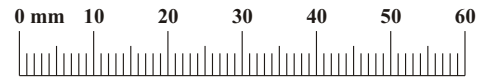

1

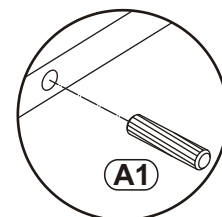
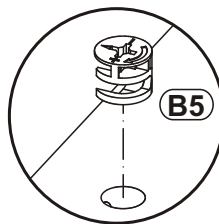
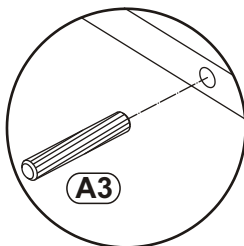
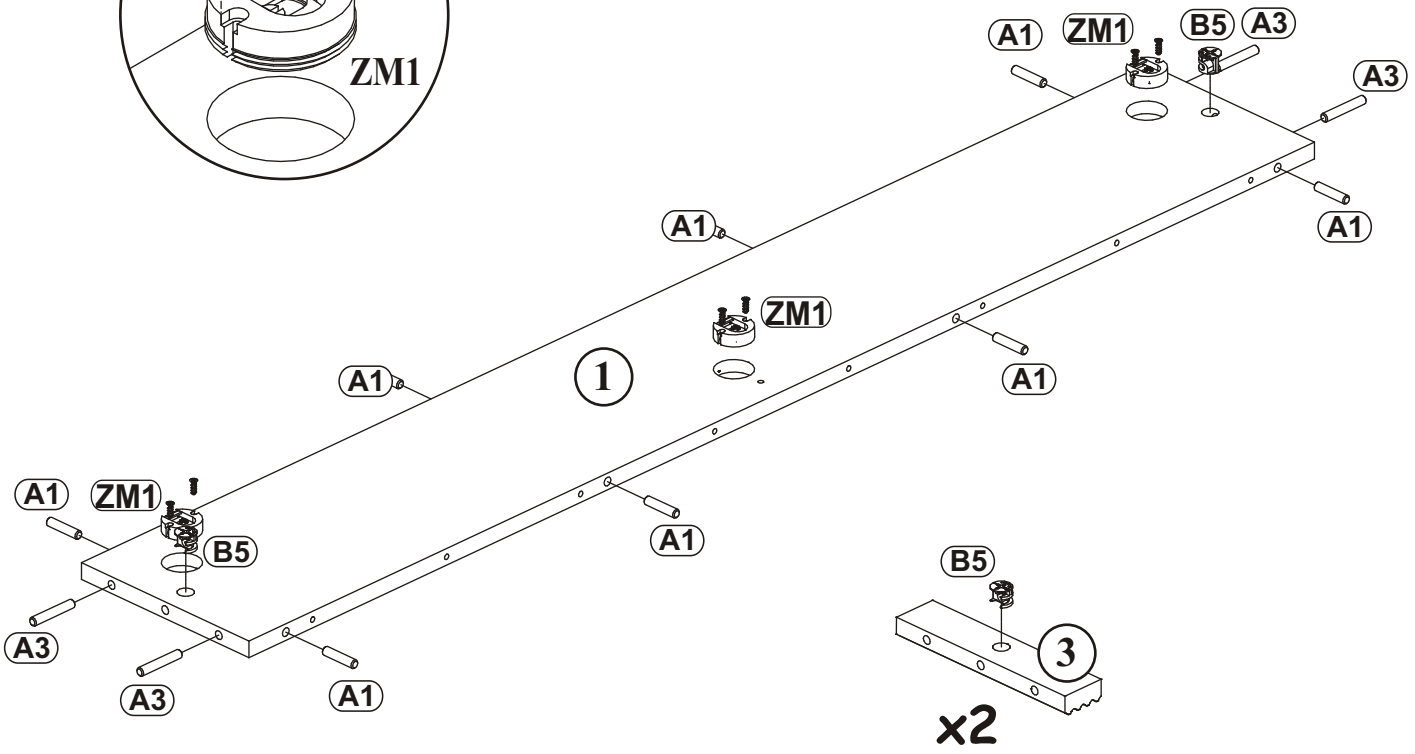
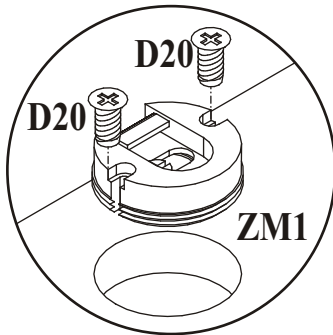
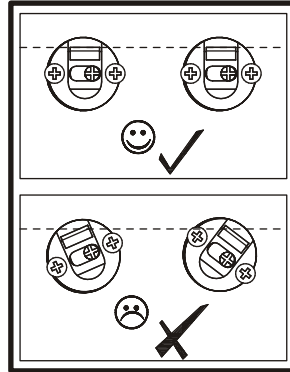
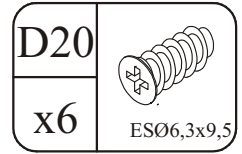
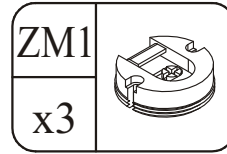
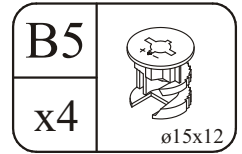
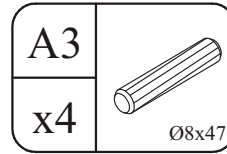
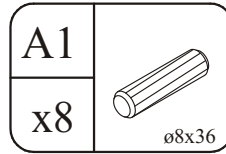

2

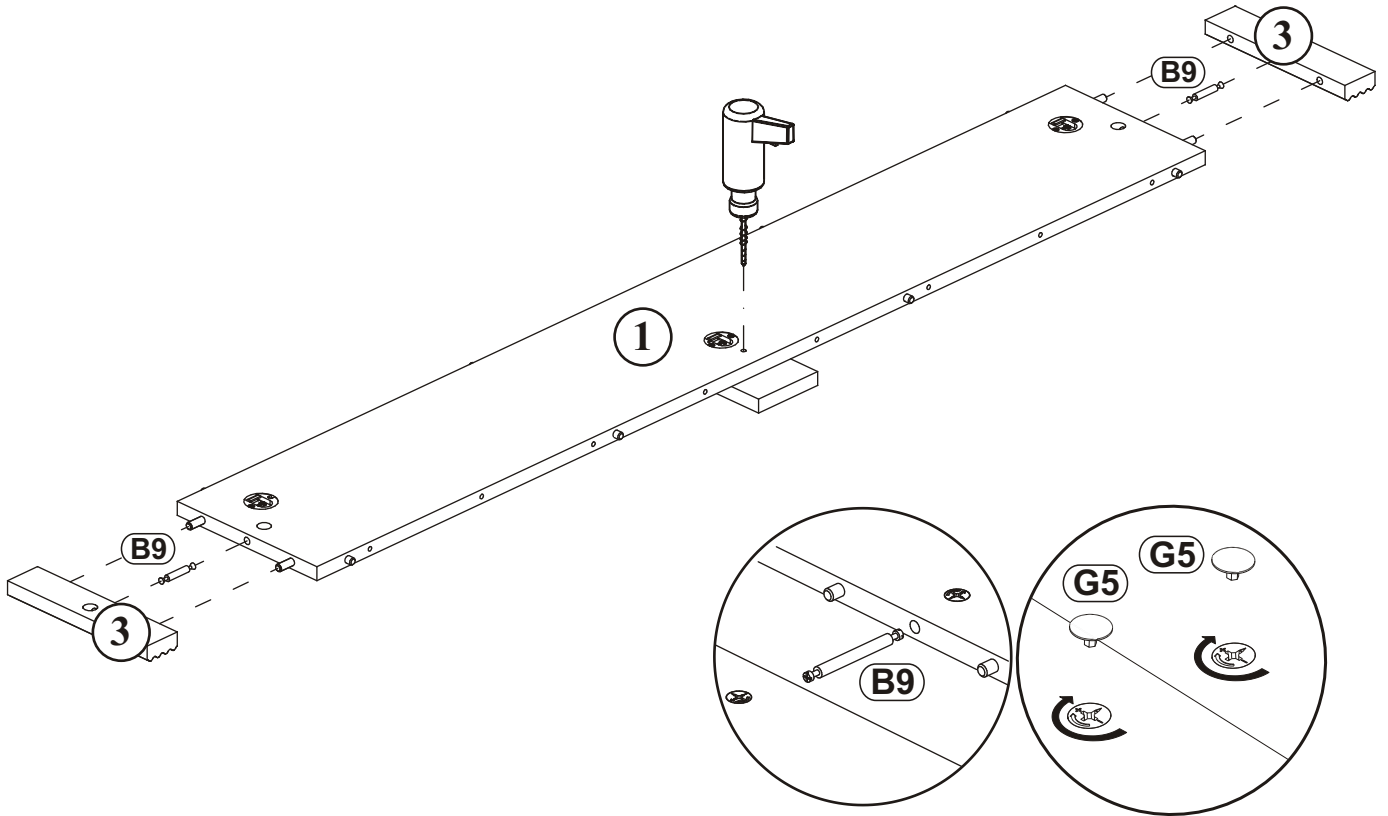
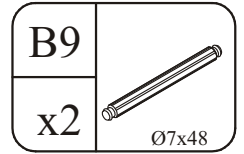
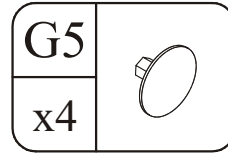
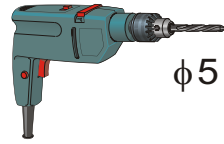

3

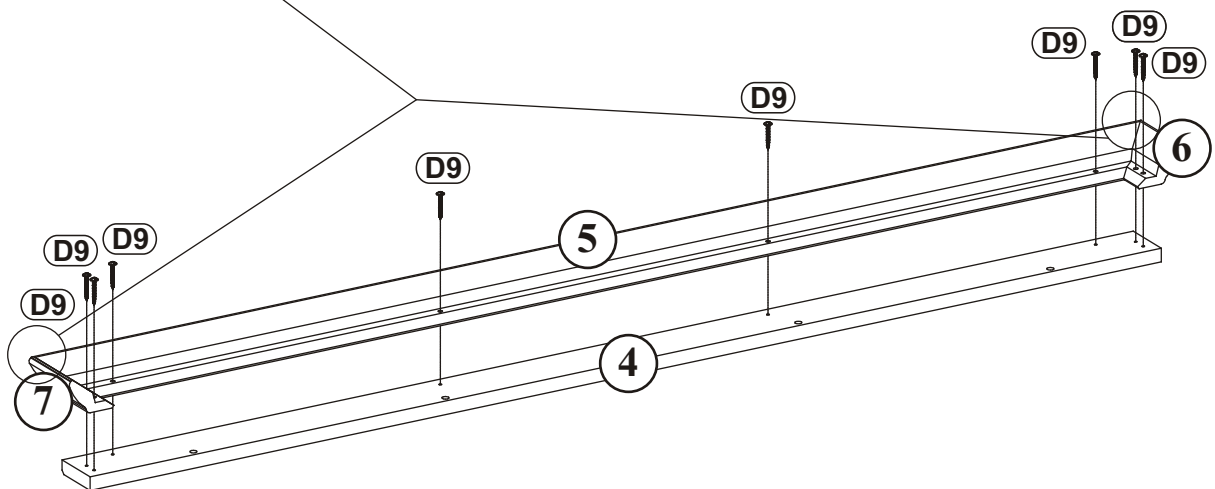
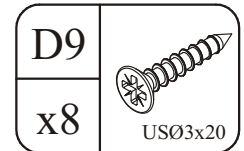
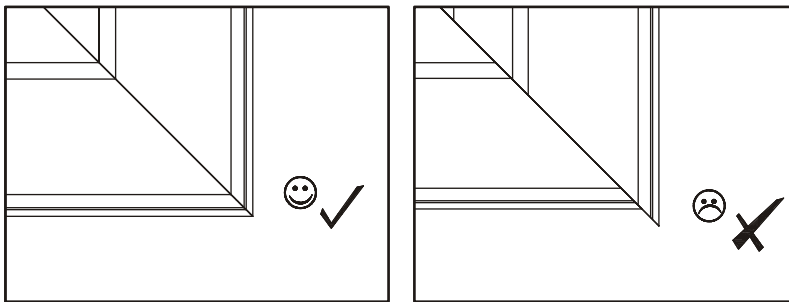

4

|     |   |
|-----|---|
| B11 |  |
| x8  | Ø7x50   |

|    |   |
|----|---|
| G4 |  |
| x8 |   |

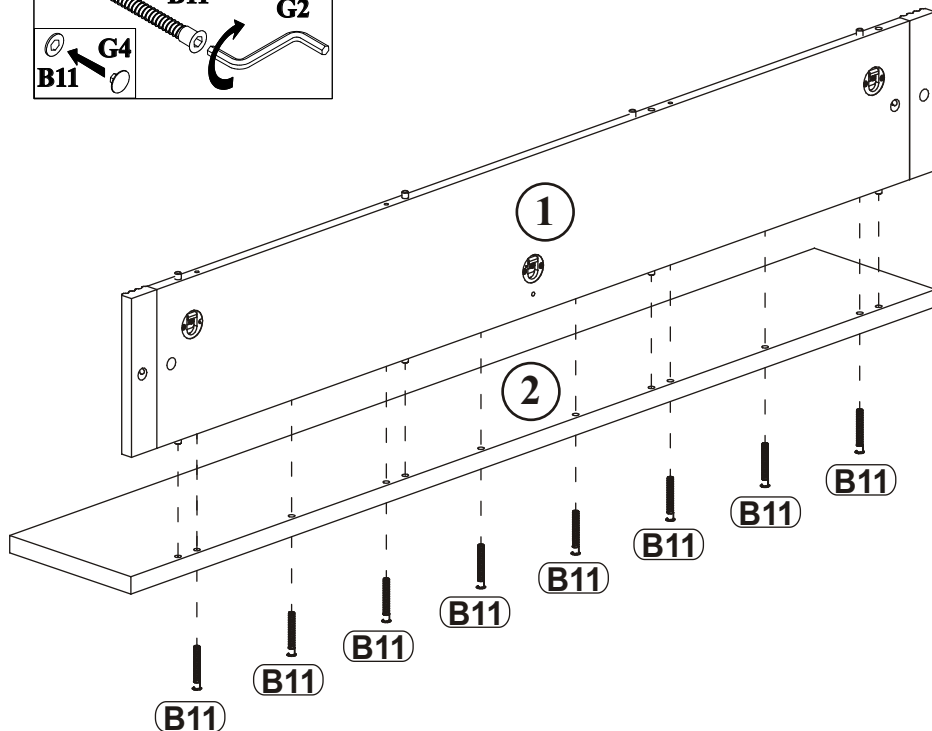
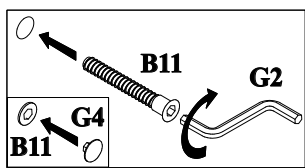

5

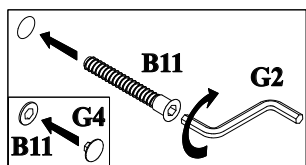

|     |   |
|-----|---|
| B11 |  |
| x4  | Ø7x50   |

|    |   |
|----|---|
| G4 |  |
| x4 |   |

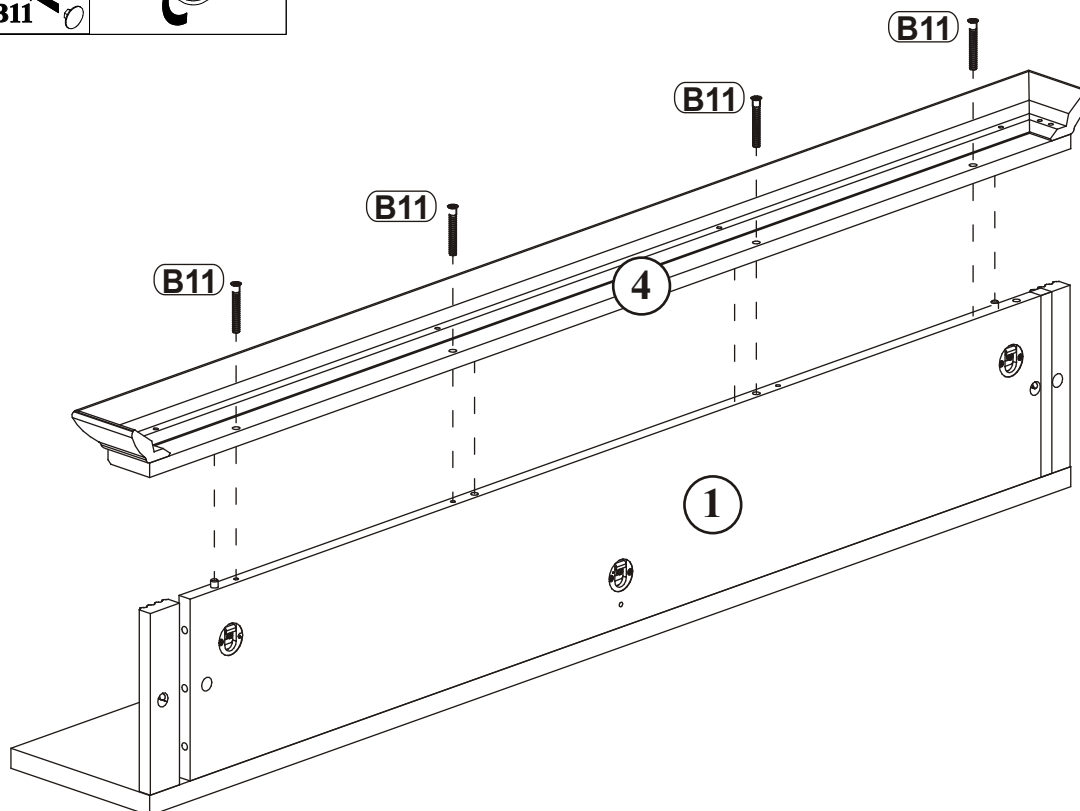

6

