











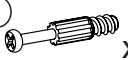

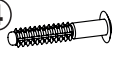
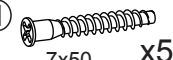

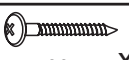
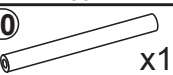





- B1**  ϕ 8x28 x54
- M1**  x10
- M12**  x4
- T1**  x14
- P2**  3x16 x8
- J23**  x7
- B4**  x8
- K1**  7x50 x5
- U90**  x2
- P5**  4x30 x4
- G20**  x1
- F10**  x5
- P17**  4x20 x5

- R11**  350 x4
- E4**  6,0x8 x8
- A1**  M4x9 x4
- L1**  x1
- L21**  x6
- P13**  3,5x13 x24
- F50**  x2
- E4**  6x8 x4
- T10**  ϕ 8x50 ϕ 4,5x60 x2
- L6**  x2
- J11**  x1
- T17**  ϕ 8x50 5x60 x1
- P13**  3,5x13 x2

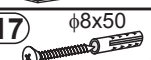
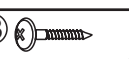
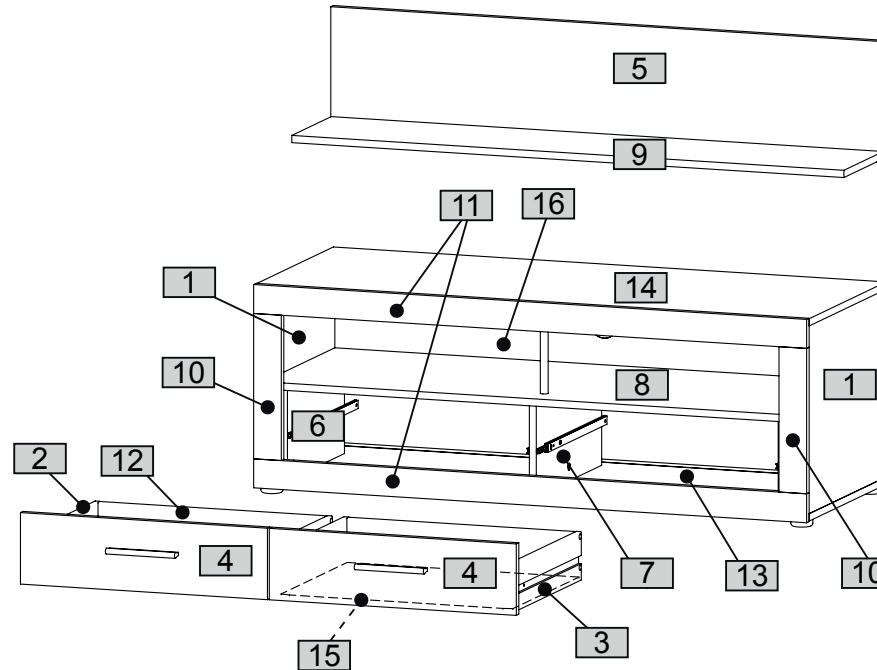

Nr	Ausmaß		St
1	389	460	15 2
2	400	100	12 2
3	400	100	12 2
4	536	148	16 2
5	1200	250	15 1
6	187	340	15 2
7	187	390	15 1
8	1168	418	15 1
9	1198	235	15 1
10	301	60	16 2
11	1200	60	16 2
12	492	100	12 2
13	1200	460	15 1
14	1200	460	15 1
15	503	399	2 2
16	1182	208	2 1

0 10 20 30 40 50 60 70 80 90 100 110 120 130 140 150 160 170 180 190 200



1

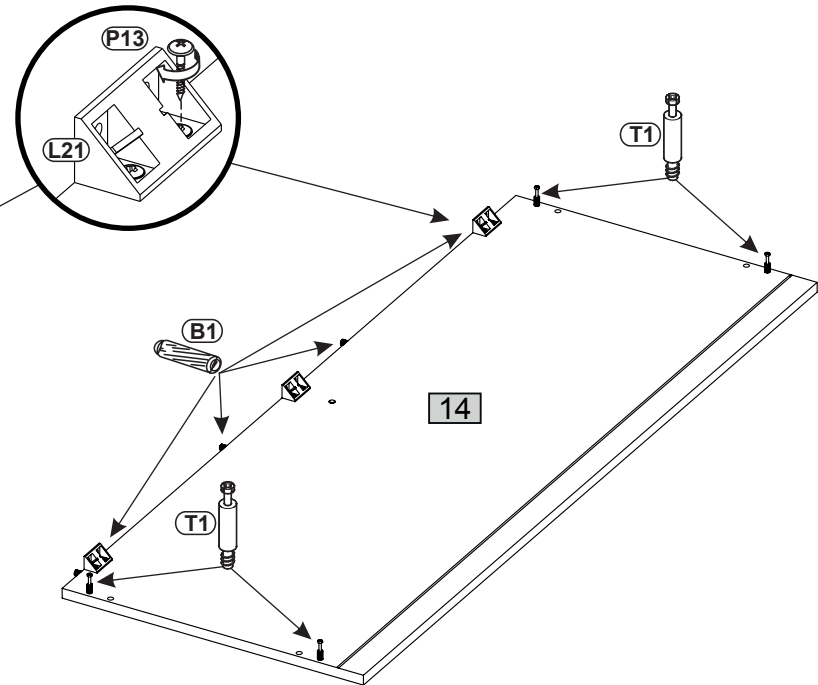
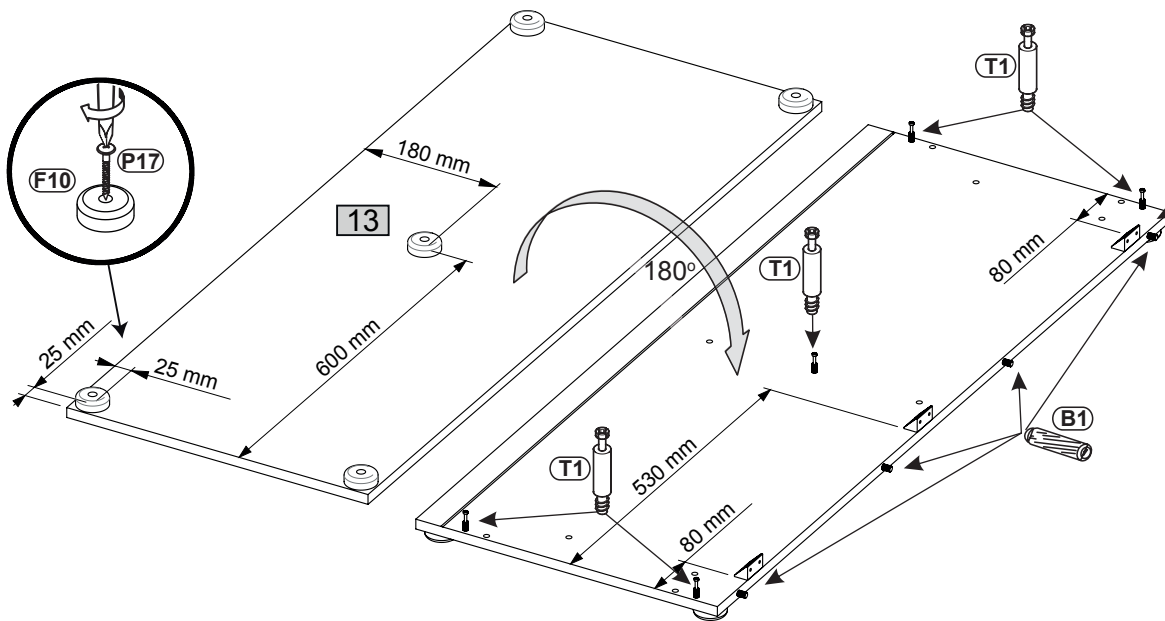
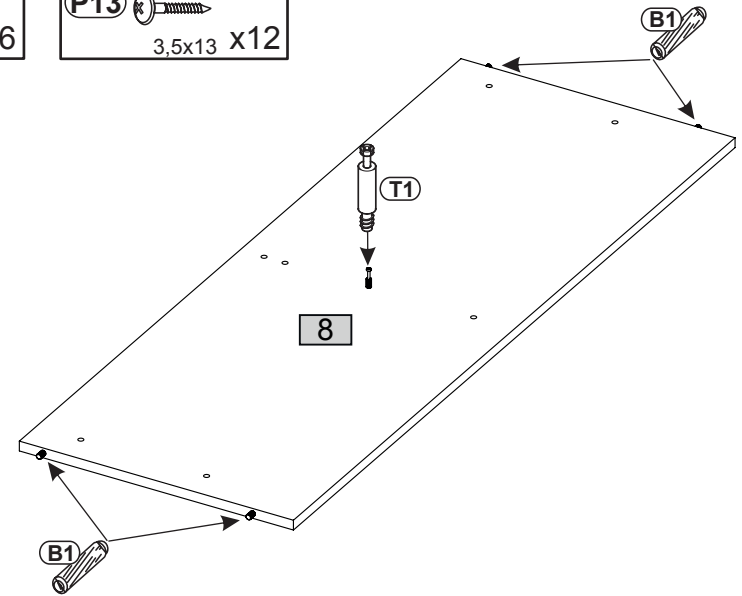
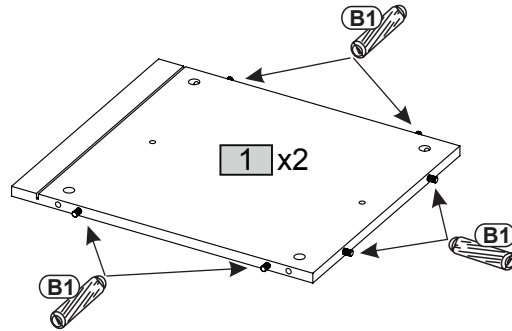
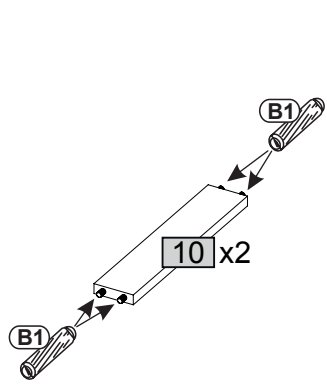
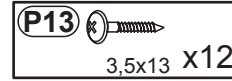
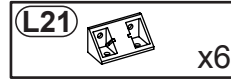
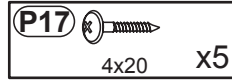
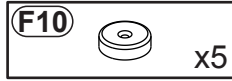
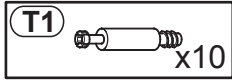
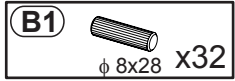

2

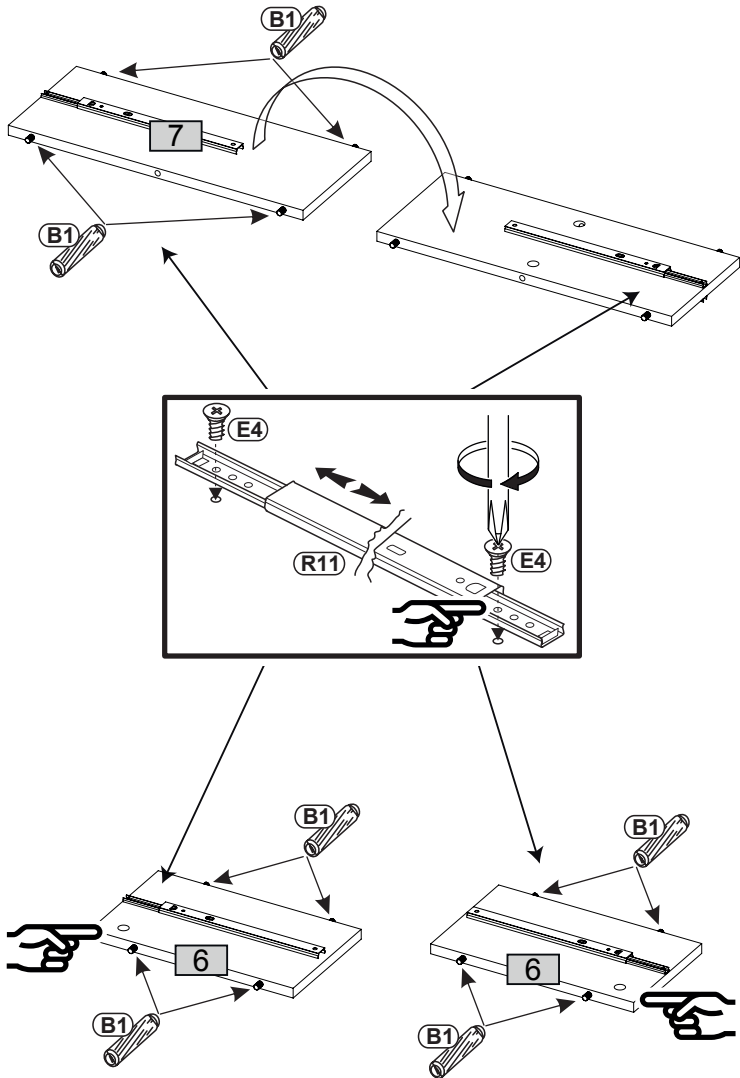
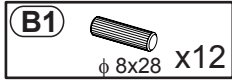
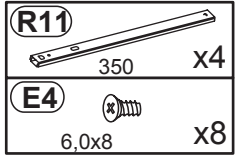

3

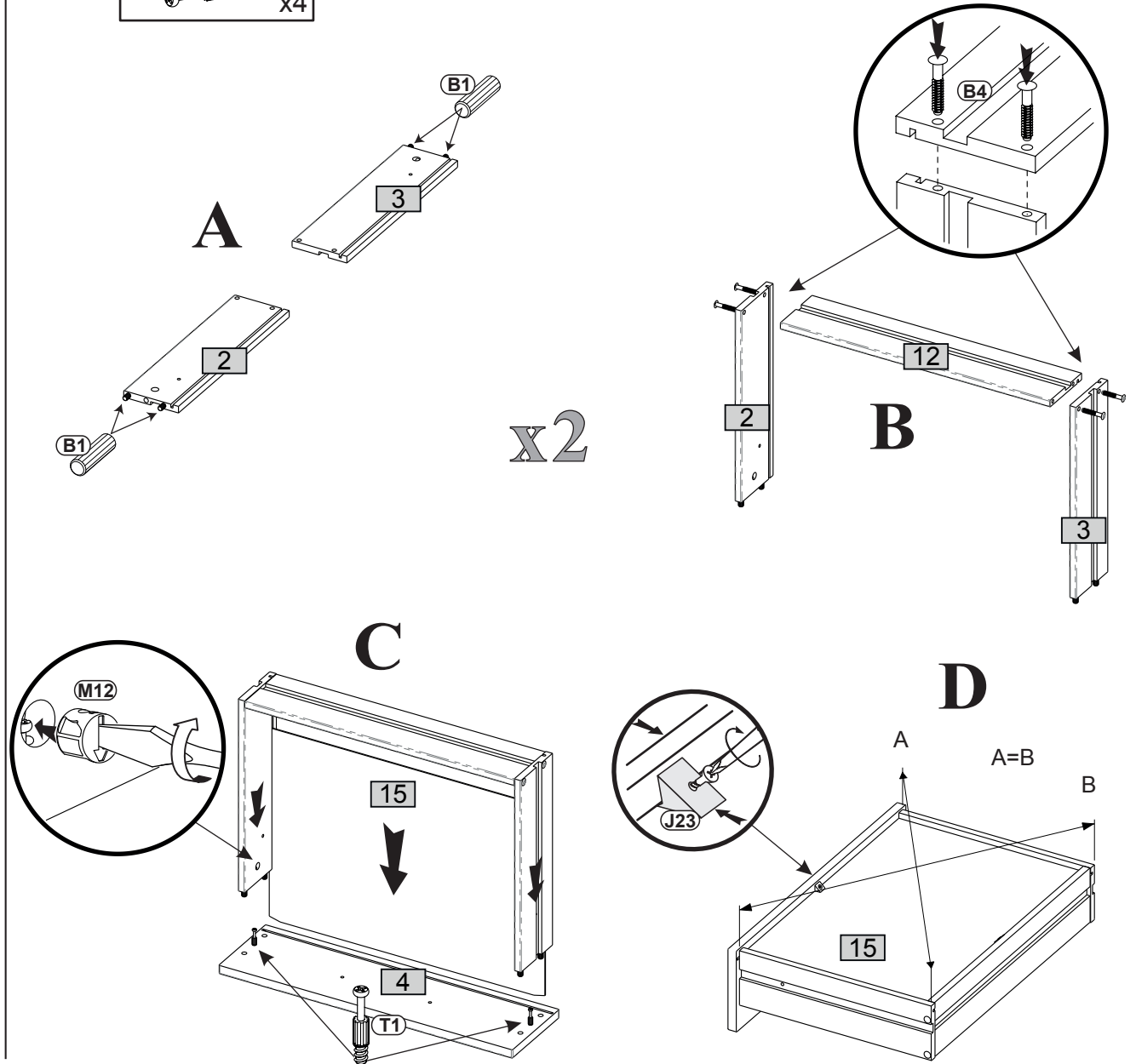
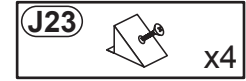
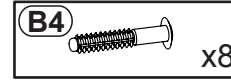
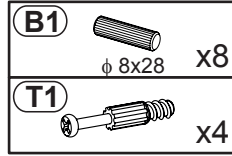

4

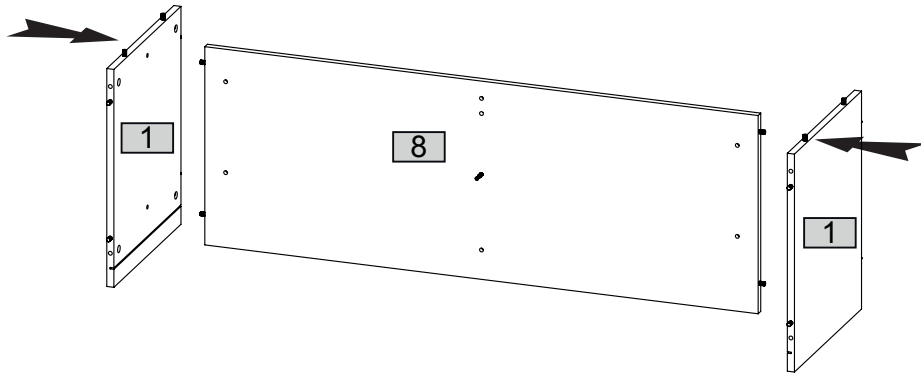

6

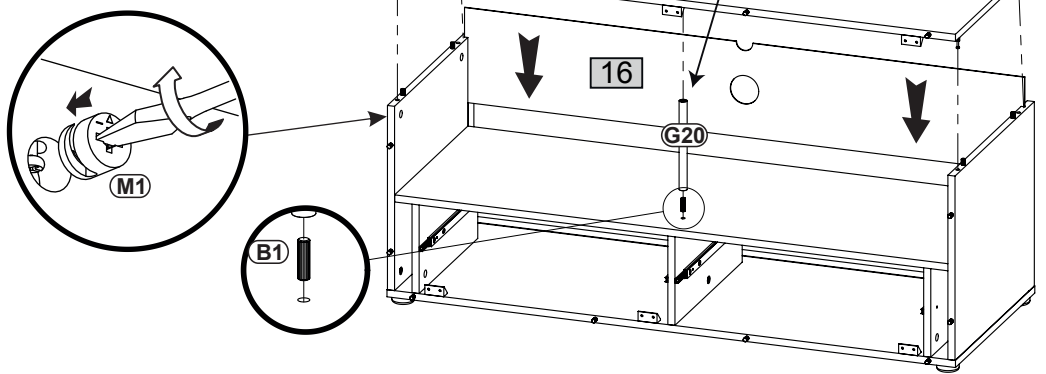
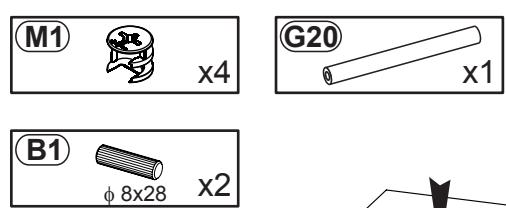

5

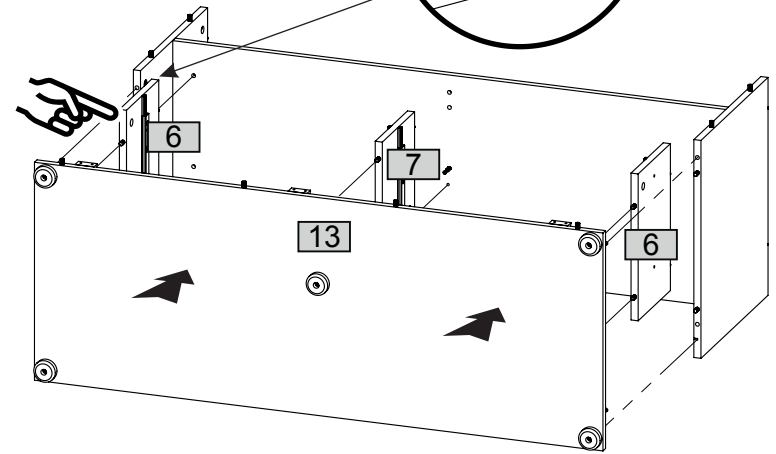
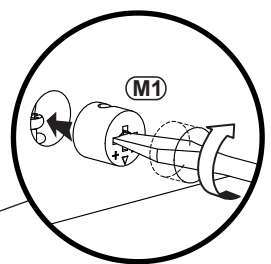

7

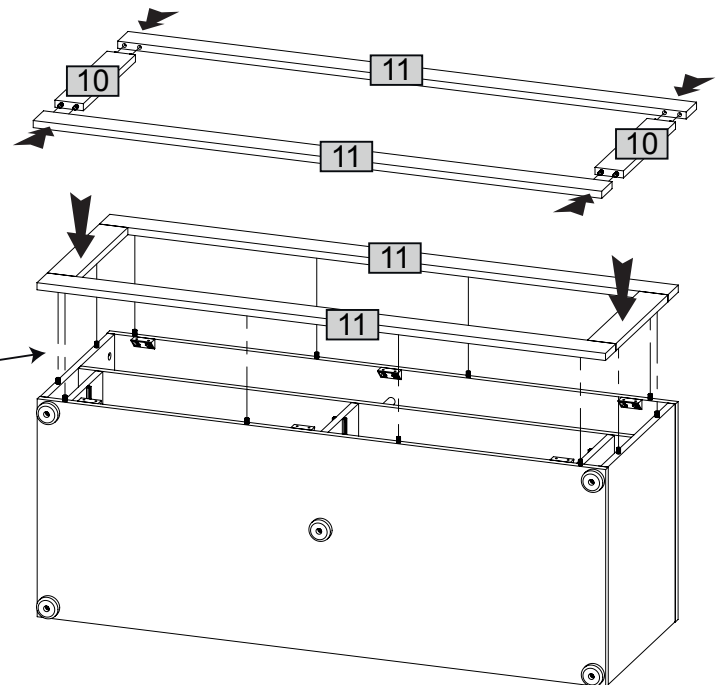
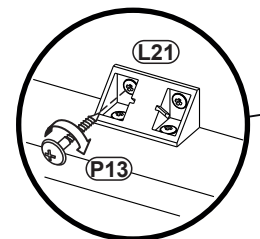
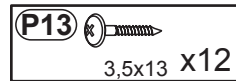

8

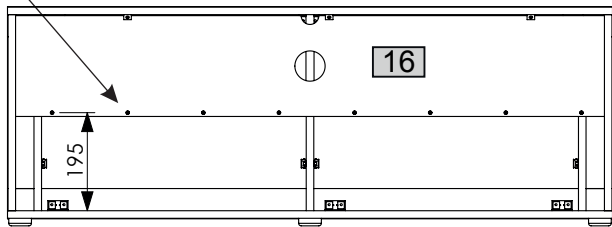
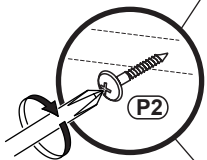
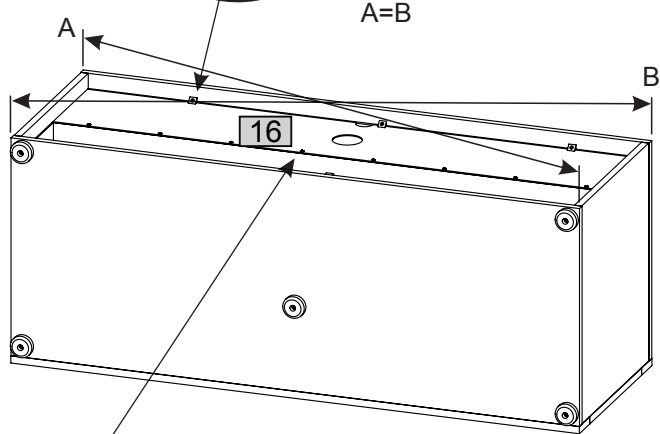
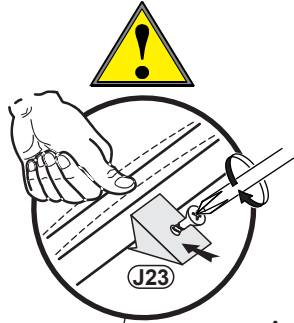
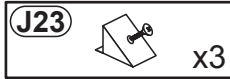
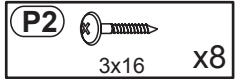

9

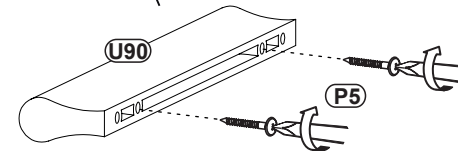
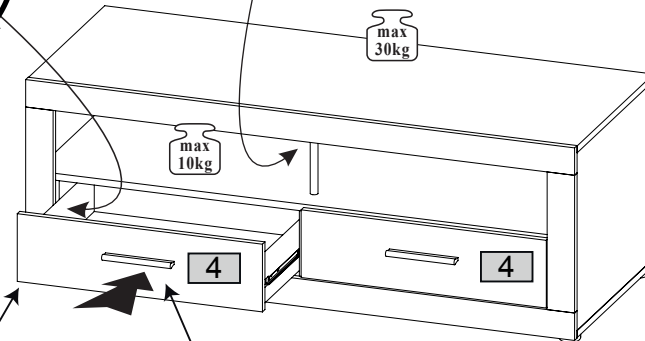
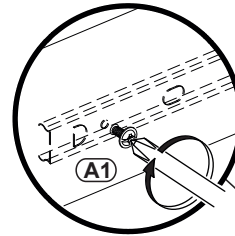
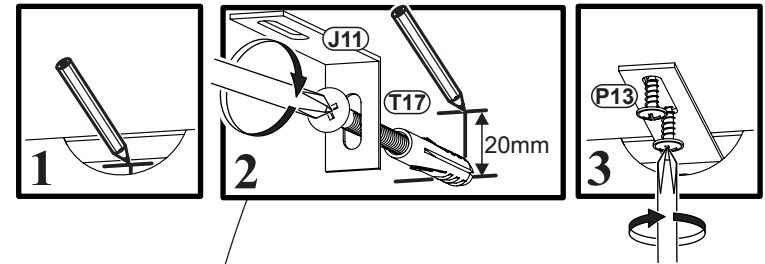
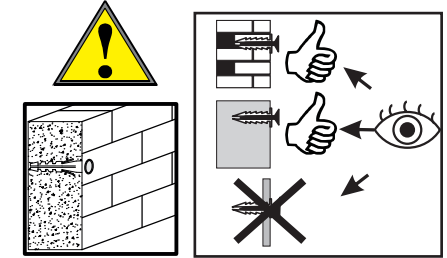
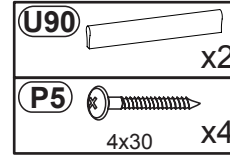
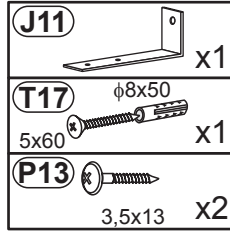

10

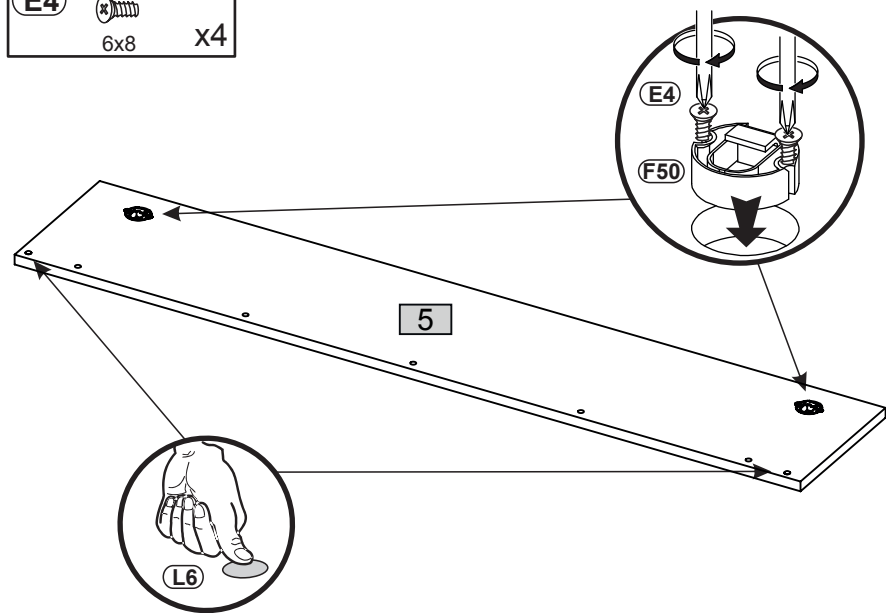
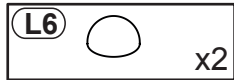
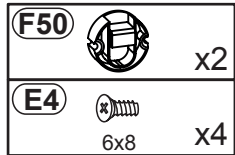

11

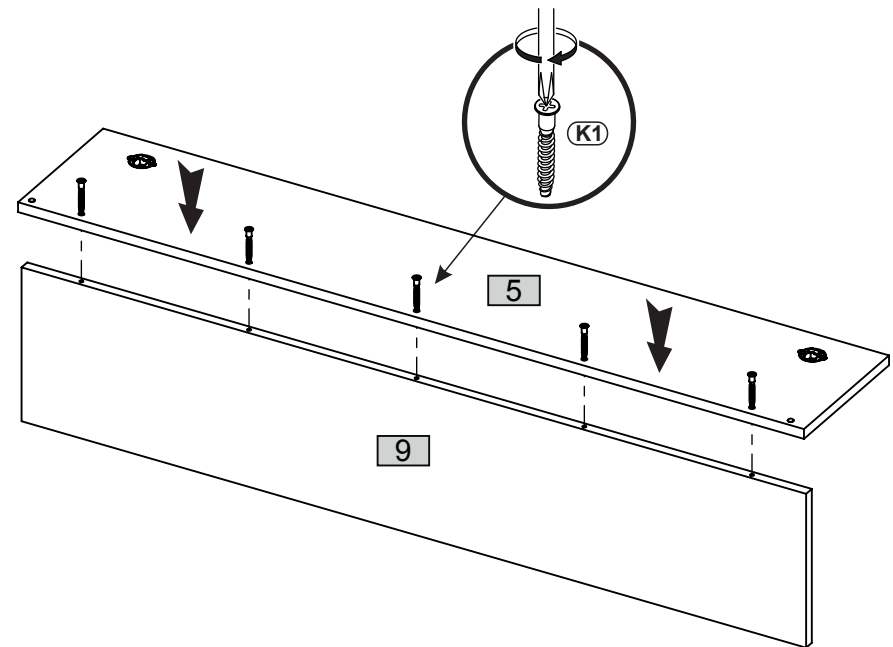
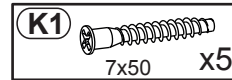

12

