

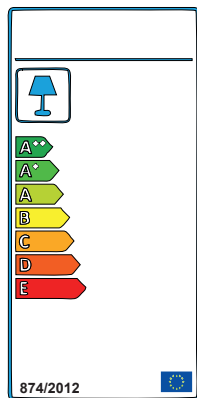

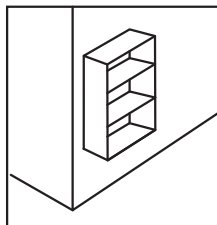

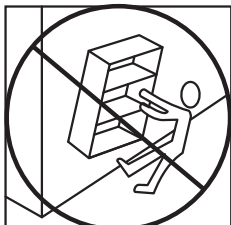

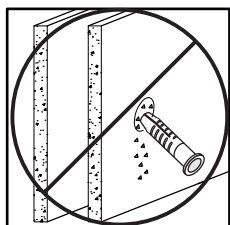

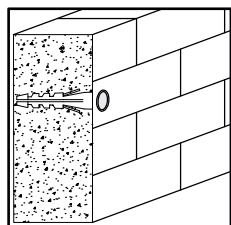
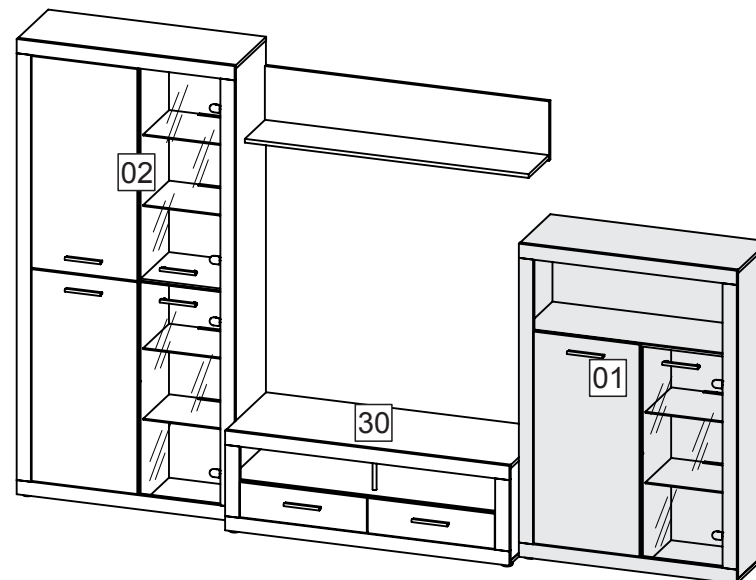
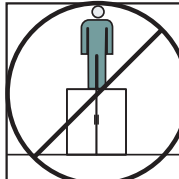
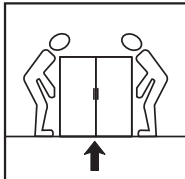
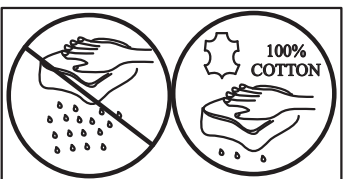
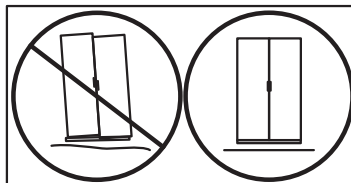
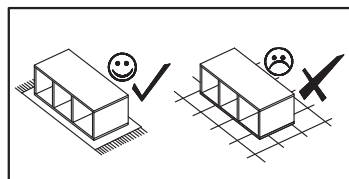
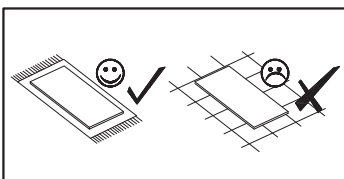
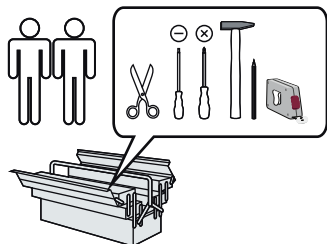
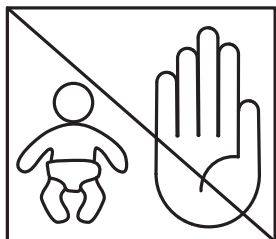

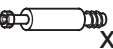





<http://www.bega-gruppe.de>





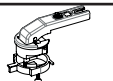





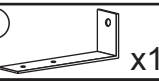
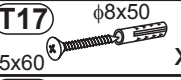

BG	Bulgarisch	Български
CS	Tschechisch	čeština
DA	Dänisch	Dansk
DE	Deutsch	Deutsch
ET	Estnisch	Eesti
EL	Griechisch	ελληνικά
EN	Englisch	English
ES	Spanisch	español
FR	Französisch	Français
FI	Finnisch	suomalainen
HR	Kroatisch	hrvatski
HU	Ungarisch	magyar
IT	Italienisch	Italiano
LV	Lettisch	Latvijas
LT	Litauisch	Lietuvos
NL	Niederländisch	Nederlands
PL	Polnisch	Polski
PT	Portugiesisch	português
RO	Rumänisch	român
SK	Slowakisch	slovenský
SL	Slowenisch	slovensčina
SV	Schwedisch	Svenska



B1		φ 8x28 x40
M1		x16
T1		x16
C2		φ 20 x16
W1		x8
W2		x8
F1		x12
P2		3x16 x12
J23		x10
L6		x1

Z25		x2
S8		4x13 x4
Y18		x2
Y19		x2
L21		x8
P13		3,5x13 x32

F10		x5
P17		4x20 x5
J11		x1
T17		φ8x50 5x60 x1
P13		3,5x13 x2

U90		x2
P5		4x30 x2
G4		x2
P17		4x20 x2
LE		x2
O51		x1

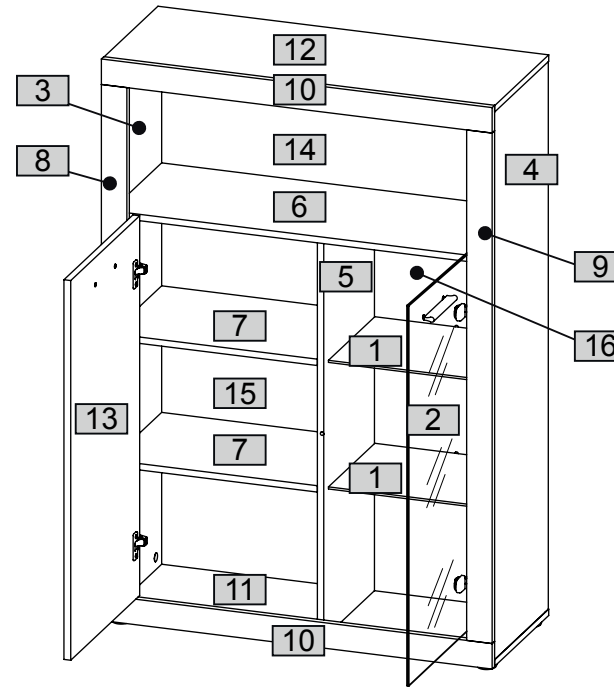

Nr	Ausmaß	St	Colli
1	385 300	5 2	1
2	895 346	4 1	1
3	1290 350	15 1	1
4	1290 350	15 1	1
5	930 328	15 1	1
6	888 329	15 1	2
7	486 328	15 2	2
8	1202 60	16 1	1
9	1202 60	16 1	1
10	920 60	16 2	2
11	920 350	15 1	1
12	920 350	15 1	1
13	446 894	16 1	2
14	902 359	2 1	2
15	944 500	2 1	2
16	944 401	2 1	2

0 10 20 30 40 50 60 70 80 90 100 110 120 130 140 150 160 170 180 190 200



1

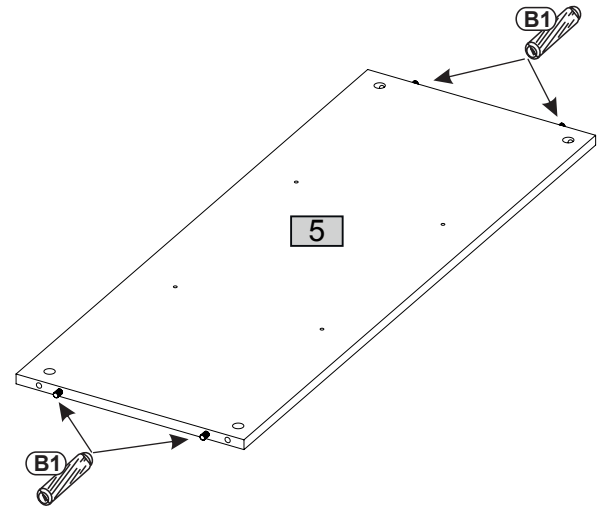
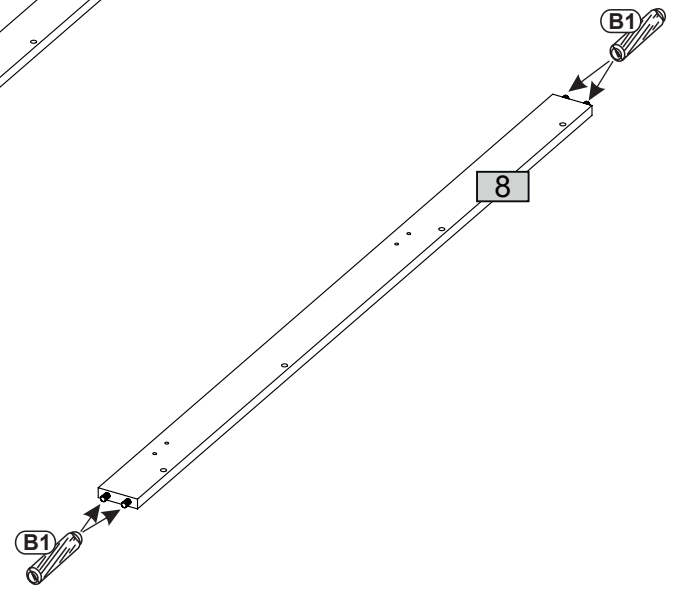
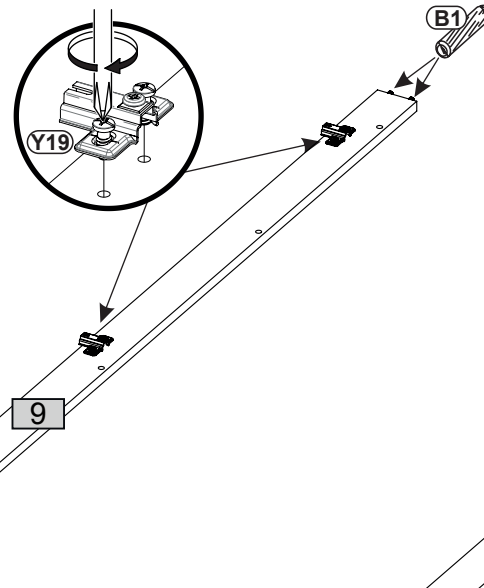
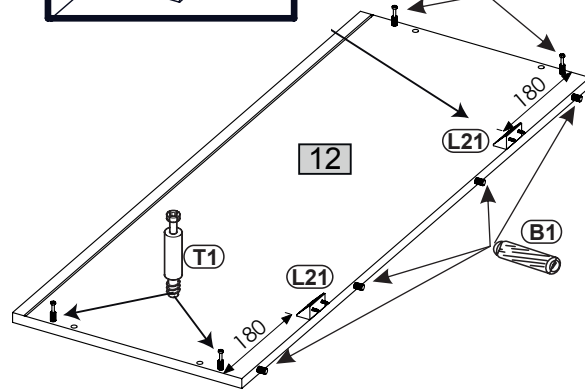
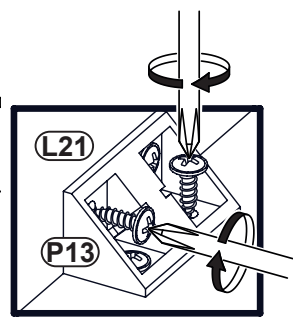
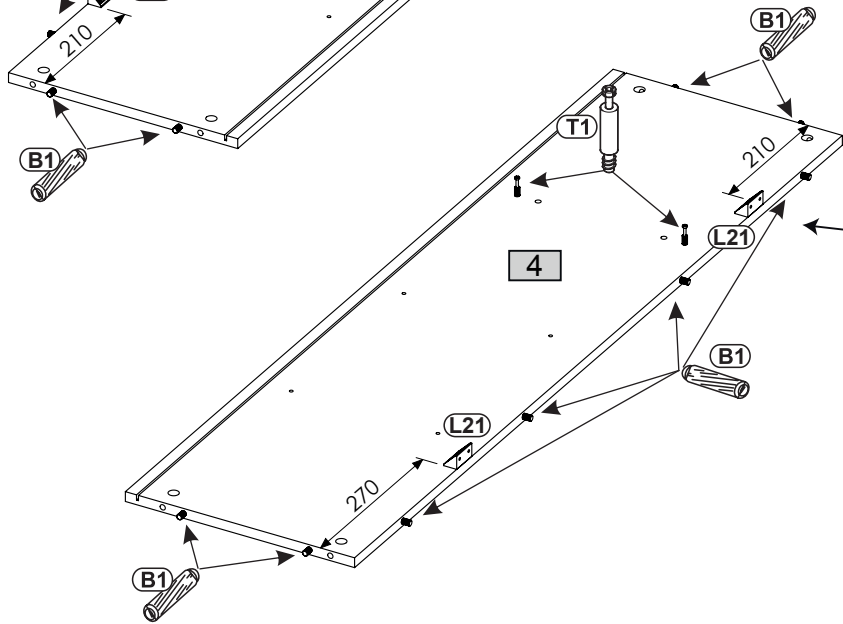
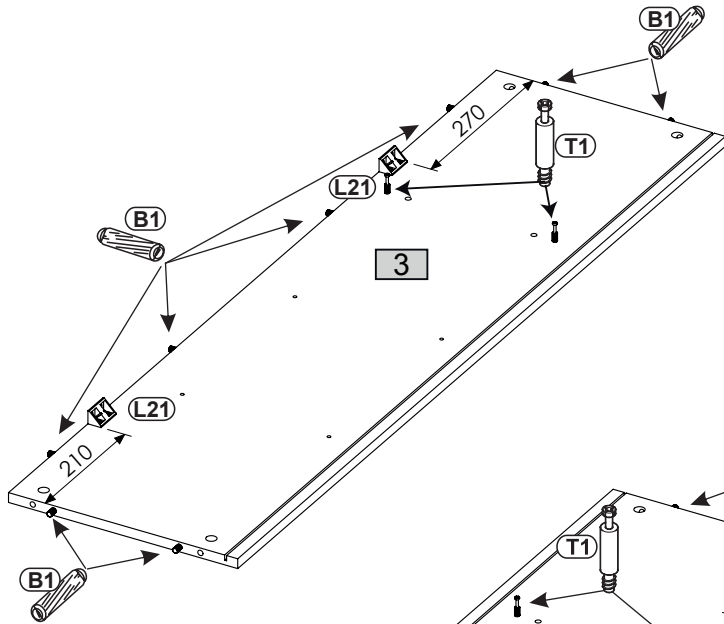
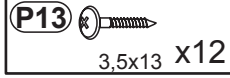
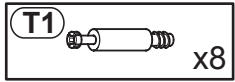
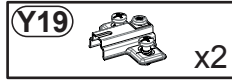
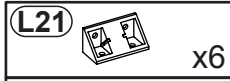
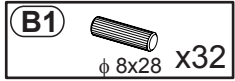

2

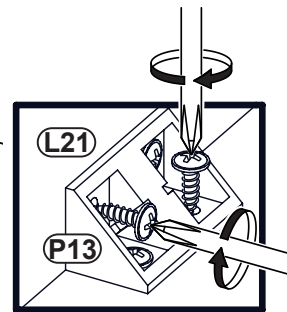
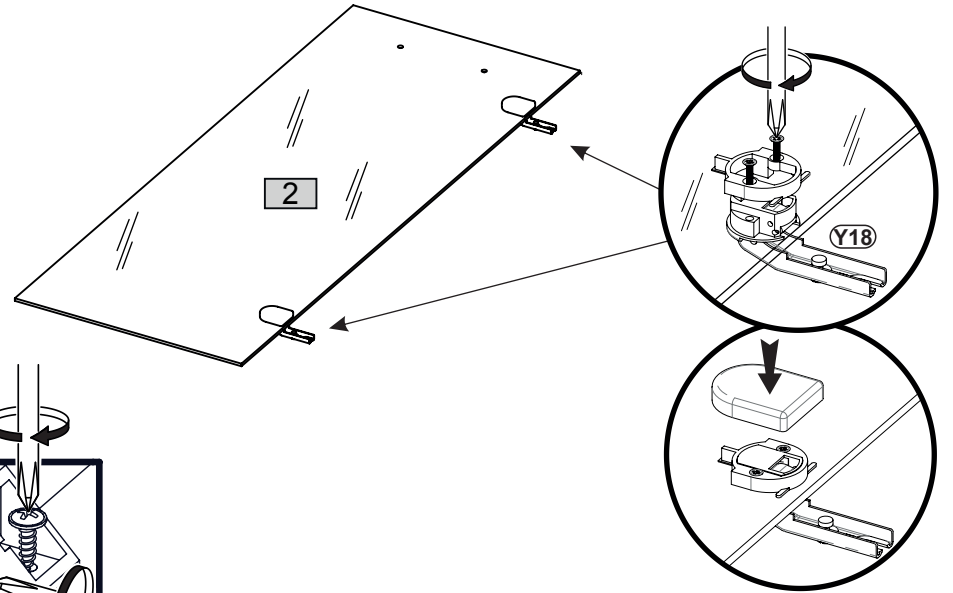
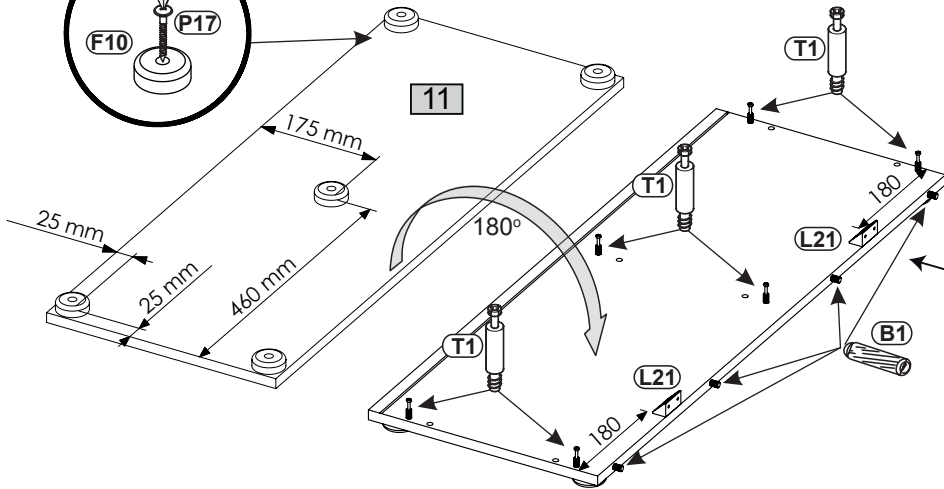
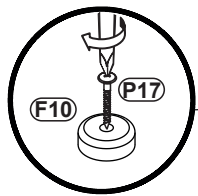
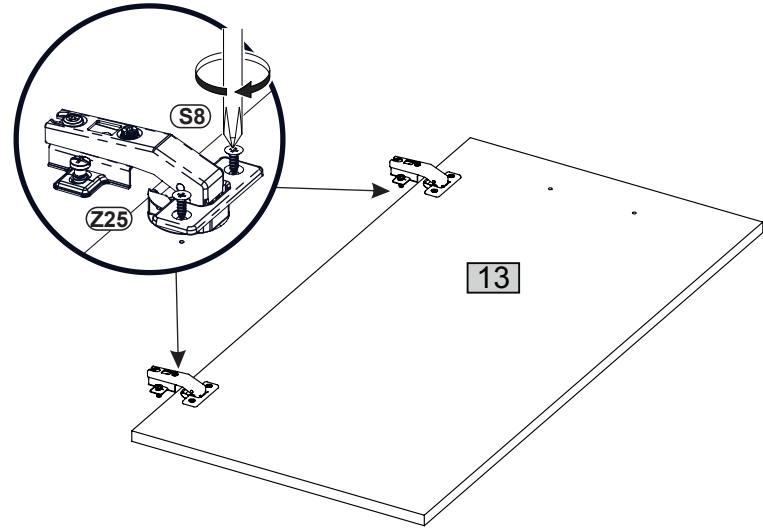
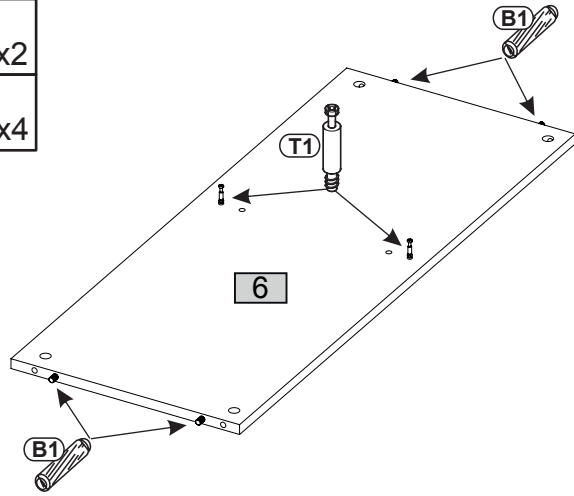
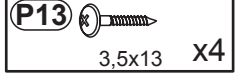
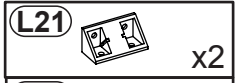
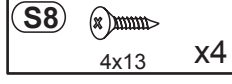
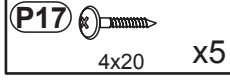
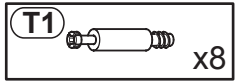
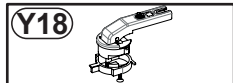
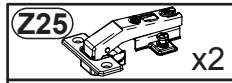
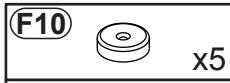
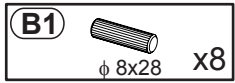

3

M1  x6

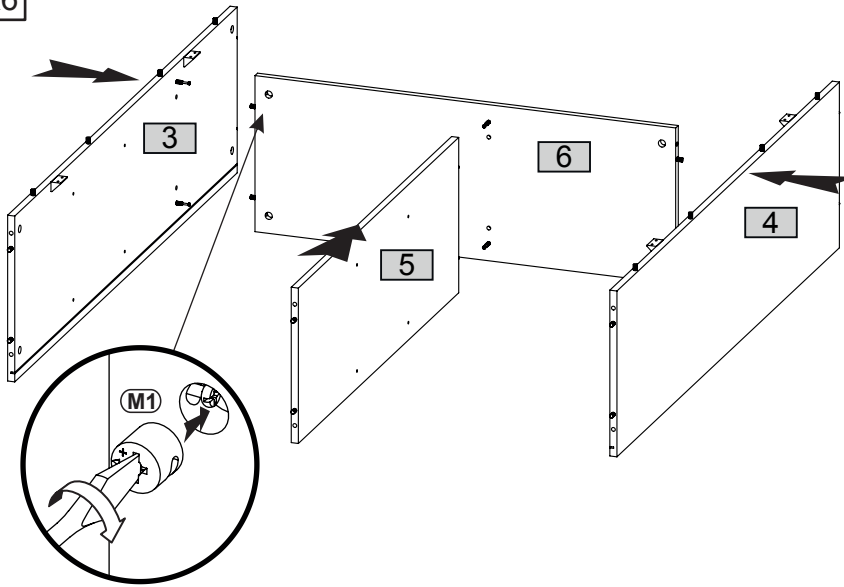

5

M1  x4

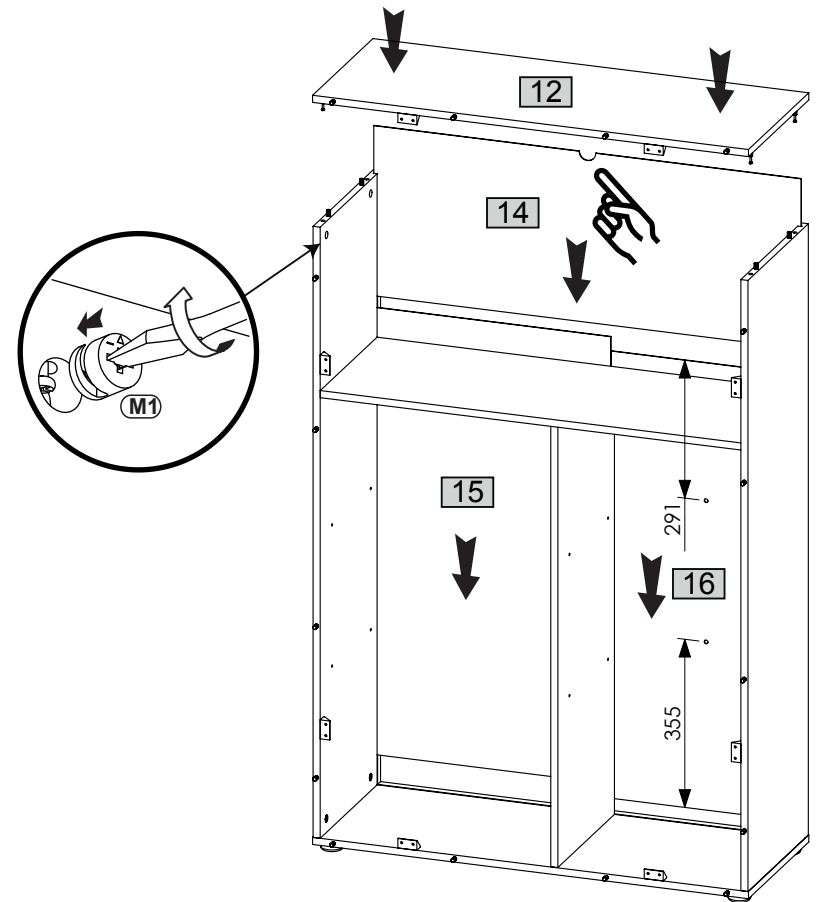

4

M1  x6

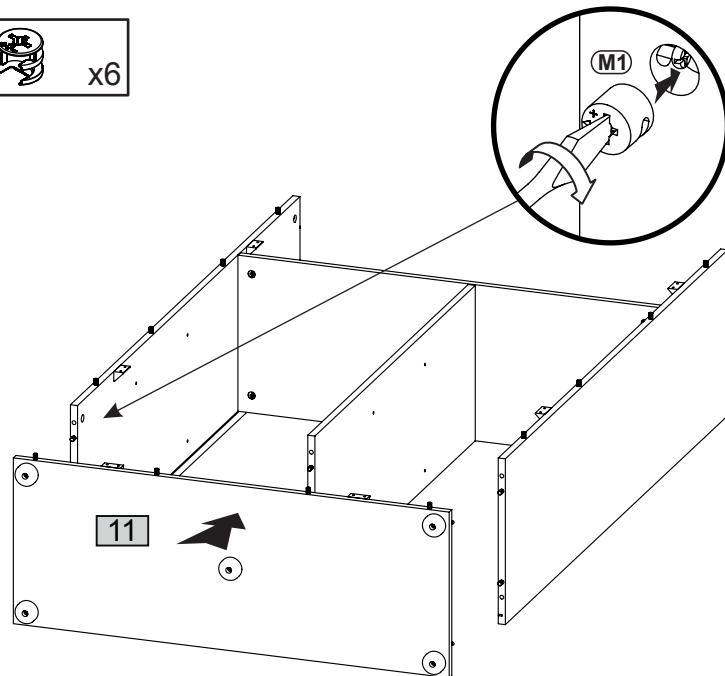

6

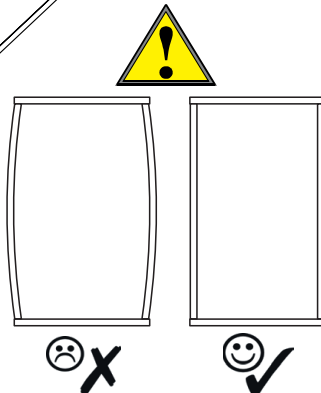
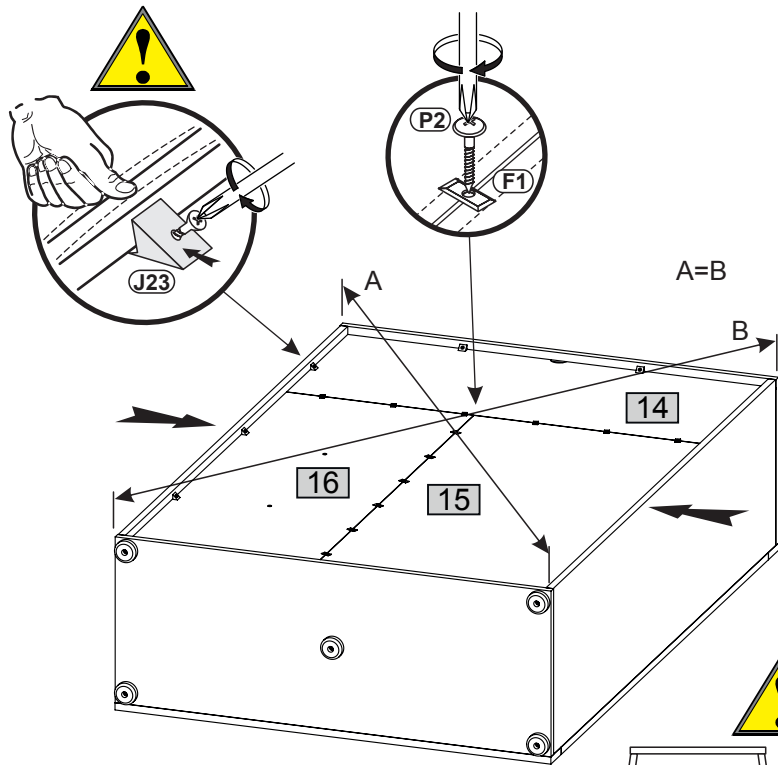
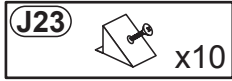
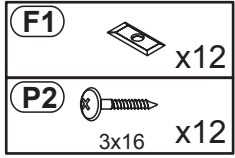

7

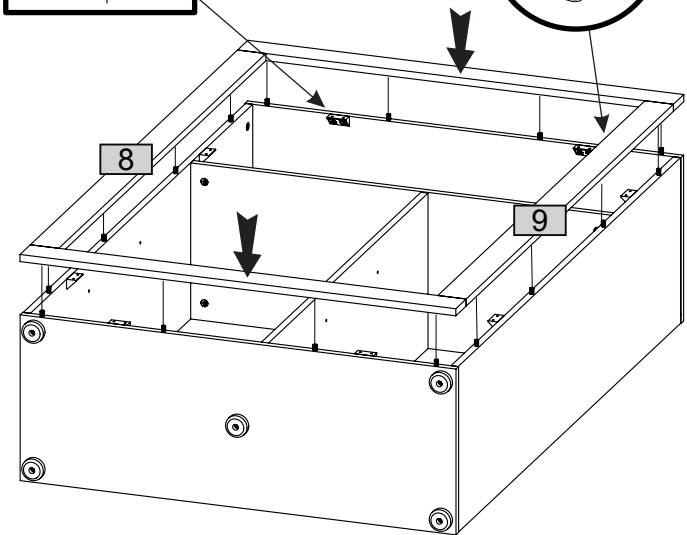
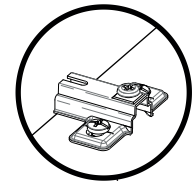
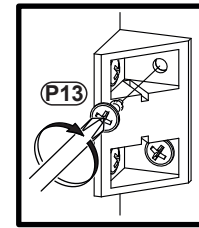
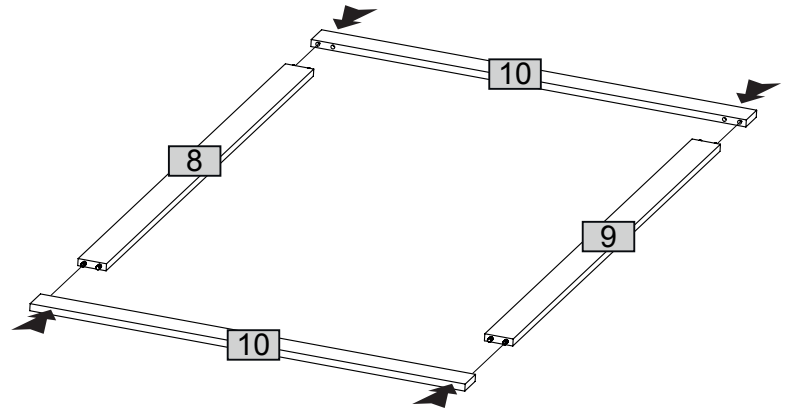
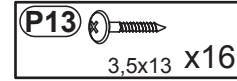

8

