











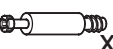









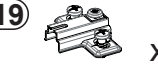

- B1**   $\phi$  8x28 x40
- M1**  x20
- T1**  x20
- C2**   $\phi$  20 x20
- W1**  x16
- W2**  x16
- F1**  x17
- P2**  3x16 x17
- J23**  x12
- L6**  x2

- Z25**  x4
- S8**  4x13 x8
- Y18**  x4
- Y19**  x4
- L21**  x10
- P13**  3,5x13 x40
- J11**  x1
- T17**   $\phi$ 8x50 5x60 x1
- P13**  3,5x13 x2

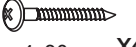
- U90**  x4
- P5**  4x30 x4
- G4**  x4
- P17**  4x20 x4
- F10**  x5
- P17**  4x20 x5

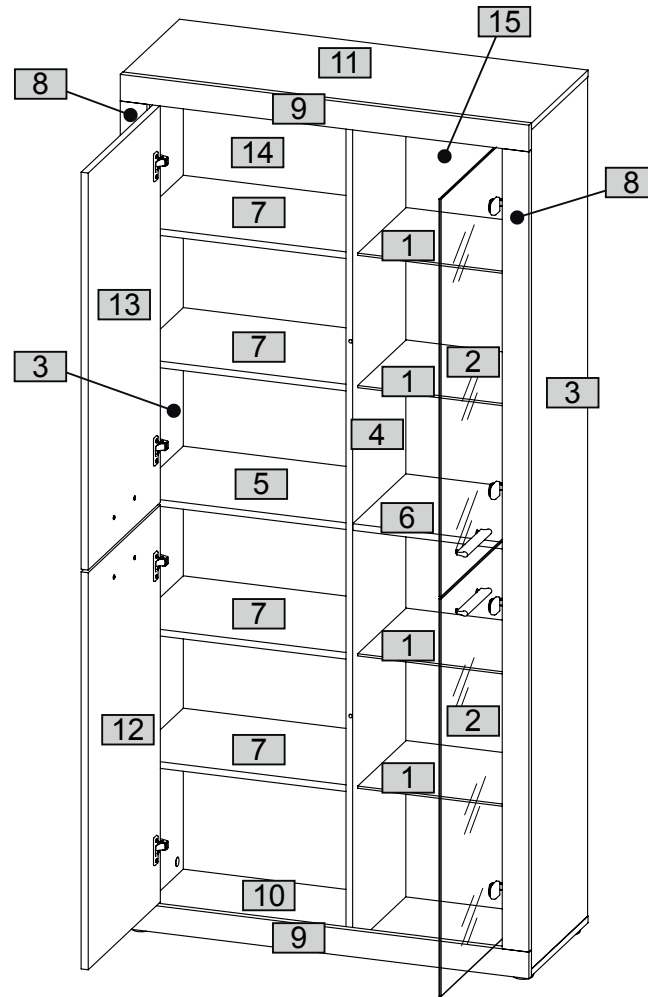

Nr	Ausmaß		St	Colli
1	385	300	5 4	4
2	895	346	4 2	4
3	1890	350	15 2	4
4	1890	329	15 1	4
5	486	328	15 1	3
6	387	328	15 1	3
7	486	328	15 4	3
8	1802	60	16 2	4
9	920	60	16 2	3
10	920	350	15 1	4
11	920	350	15 1	4
12	446	894	16 1	3
13	446	894	16 1	3
14	951	500	2 2	3
15	951	401	2 2	3

0 10 20 30 40 50 60 70 80 90 100 110 120 130 140 150 160 170 180 190 200



1

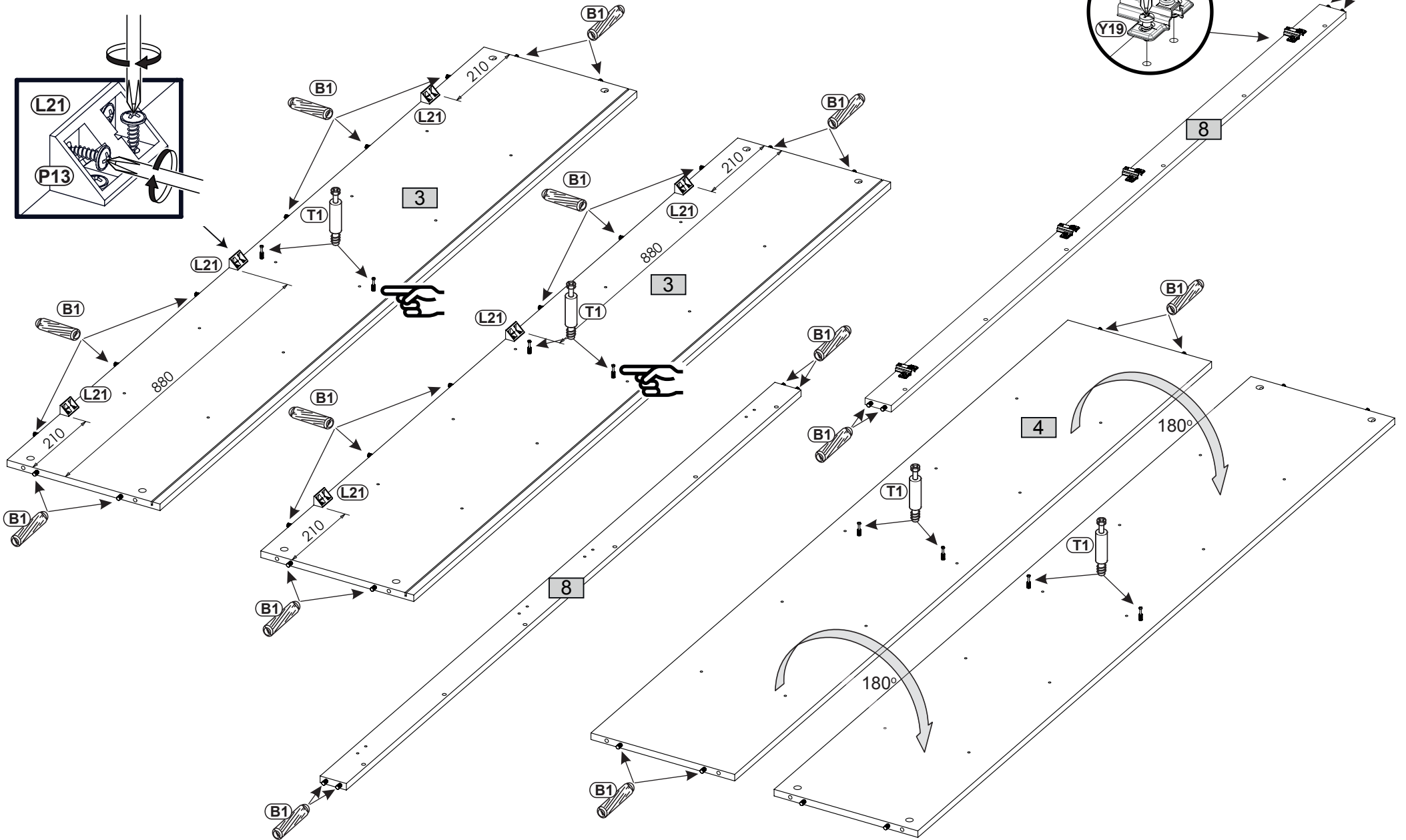
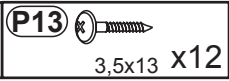
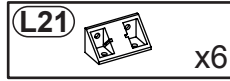
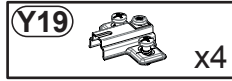
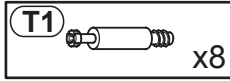
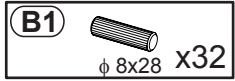

2

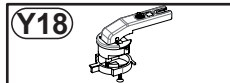
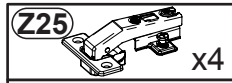
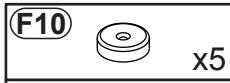
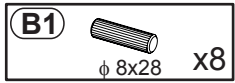

3

M1  x8

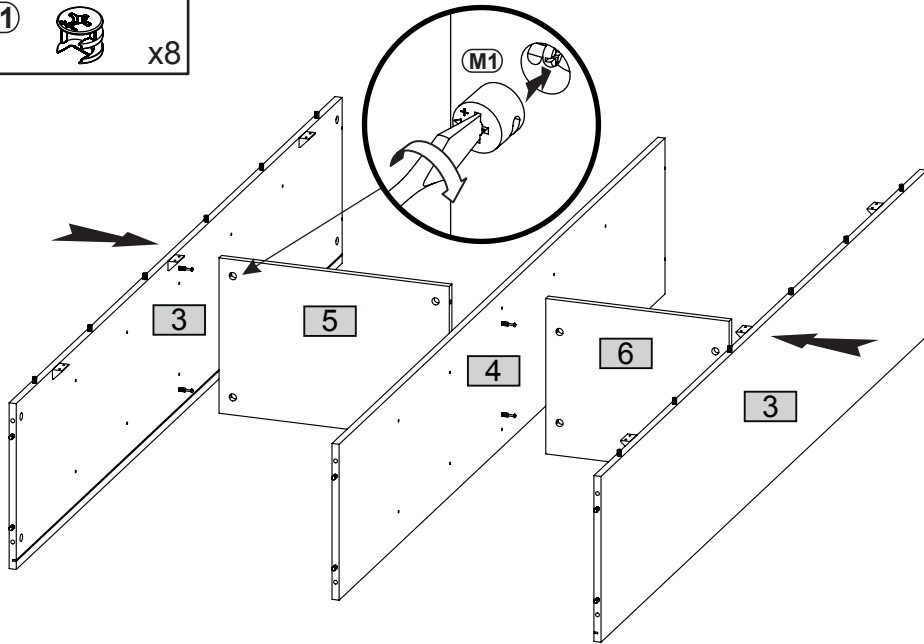

5

M1  x6

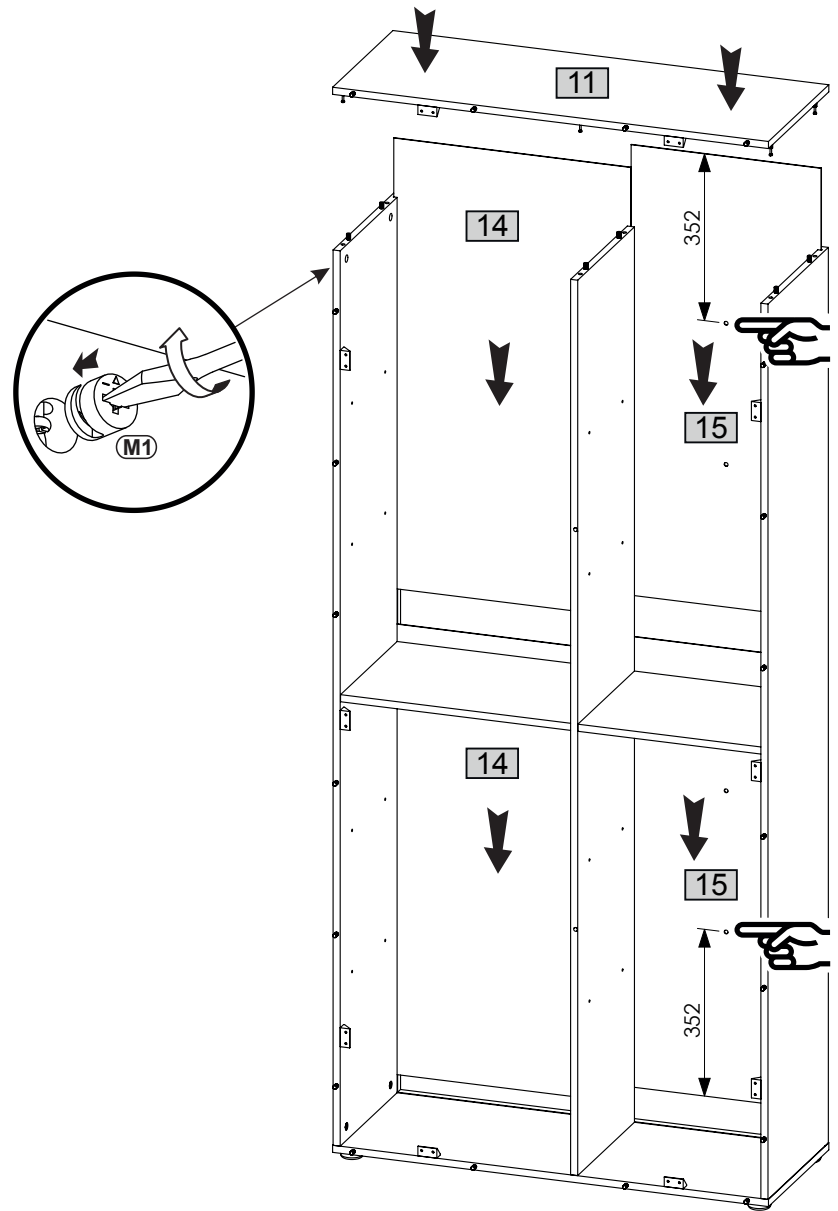

4

M1  x6

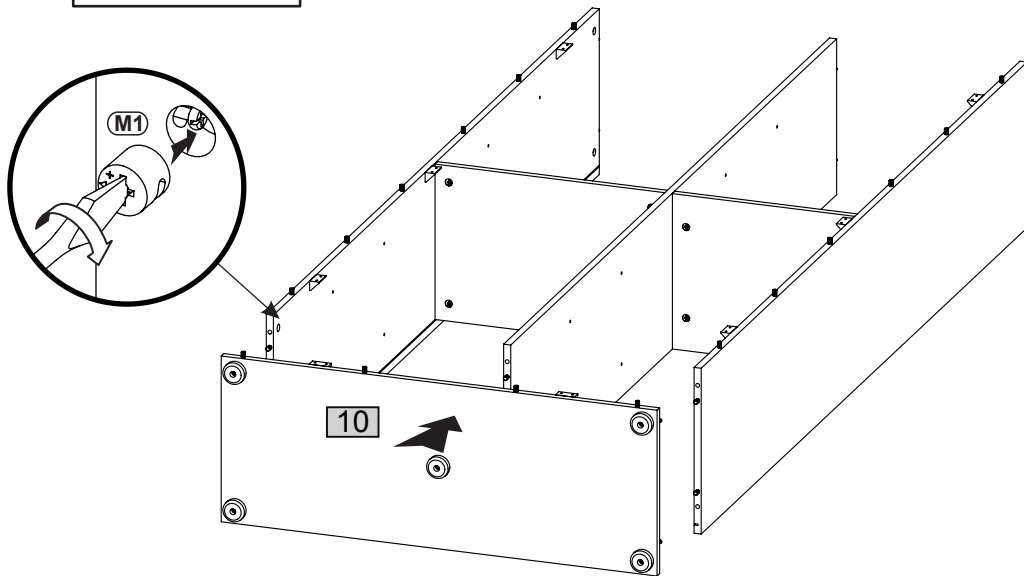



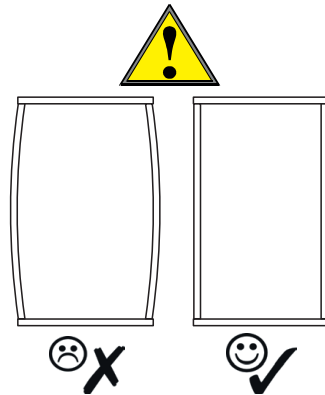
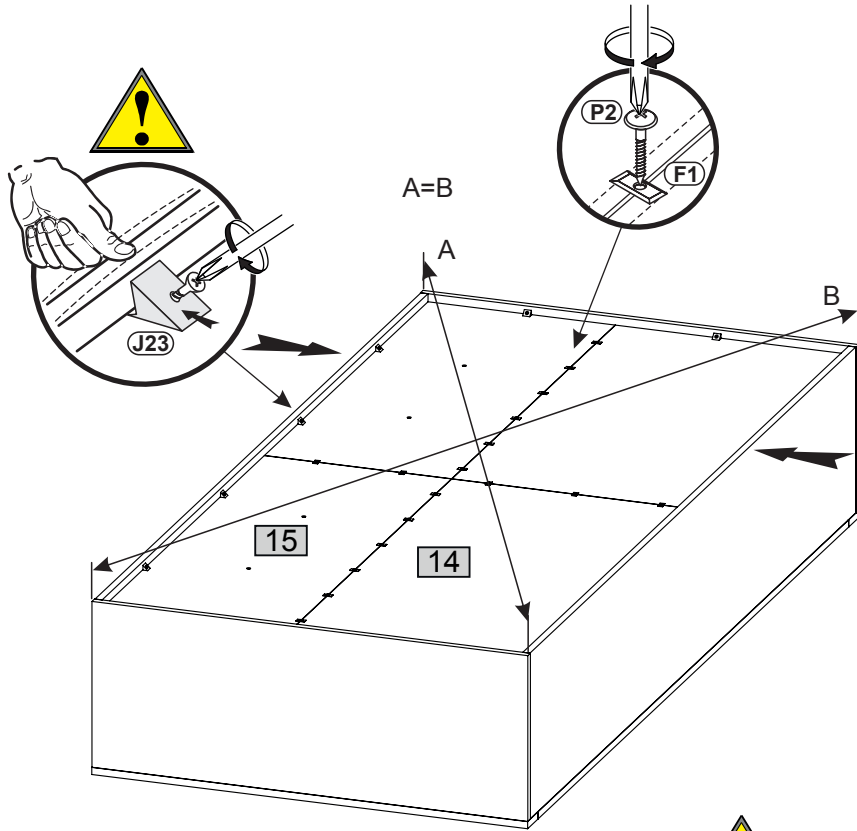
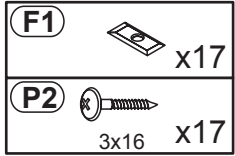

6

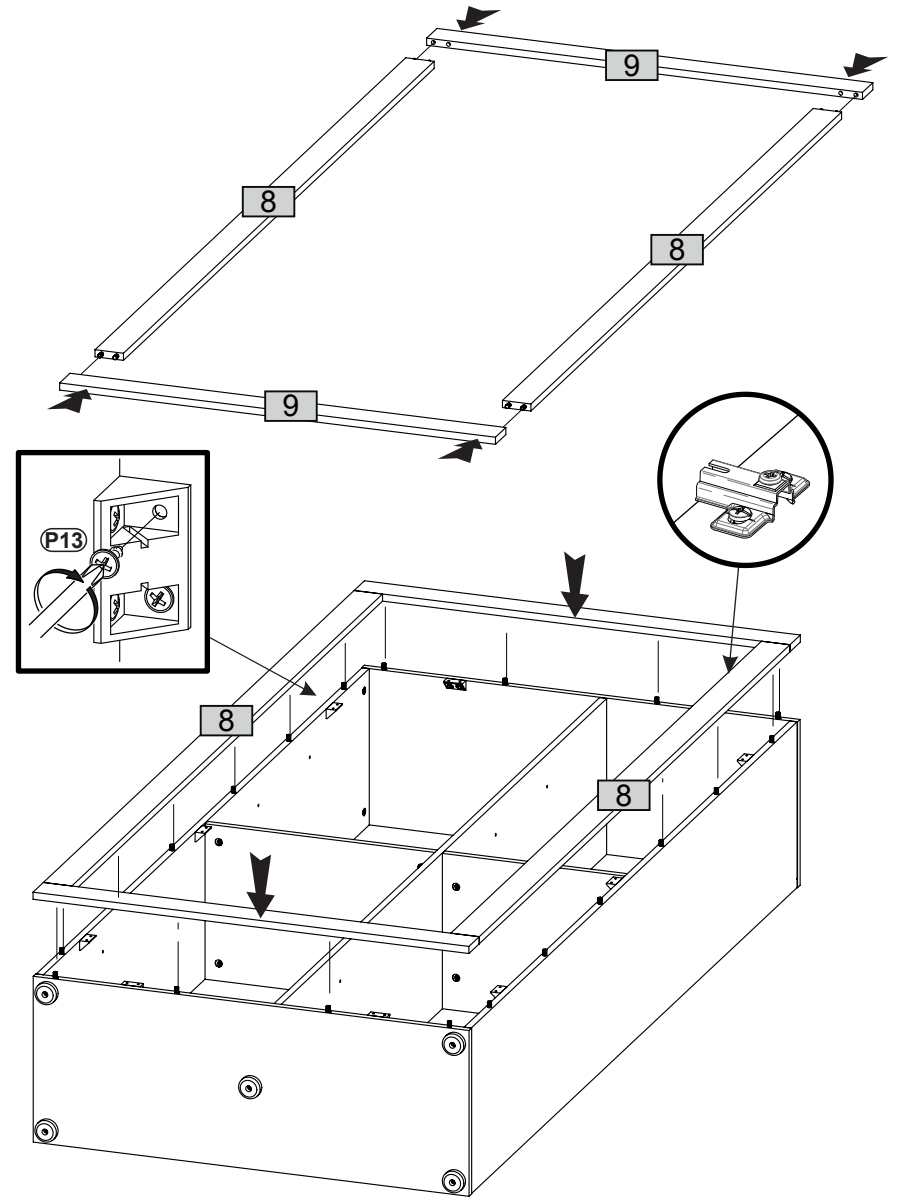
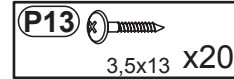

7

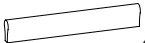



8

- U90**  x4
- P5**  4x30 x4
- G4**  x4
- P17**  4x20 x4

- L6**  x2

- C2**   $\phi$  20 x20

- W1**  x16

- W2**  x16

- J11**  x1

- T17**   $\phi$ 8x50 x1

- P13**  3,5x13 x2

