

BERND

W09

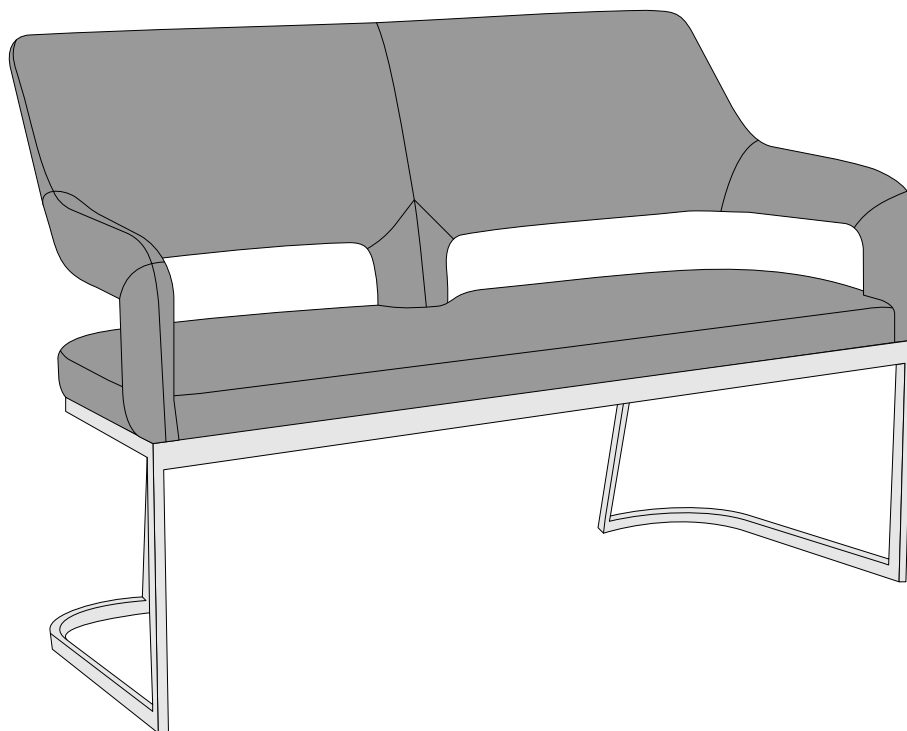

10-0590

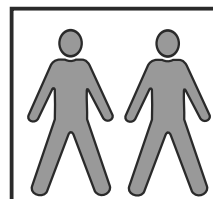

231117V3

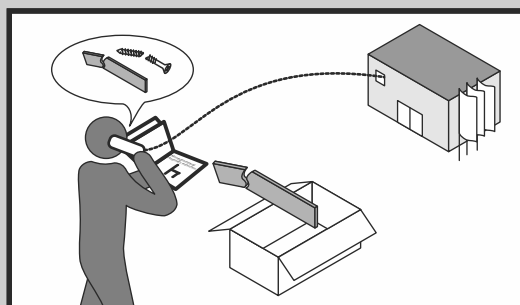
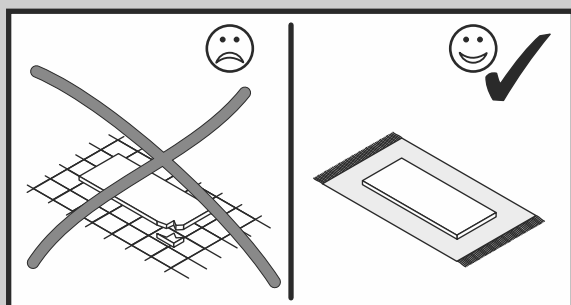
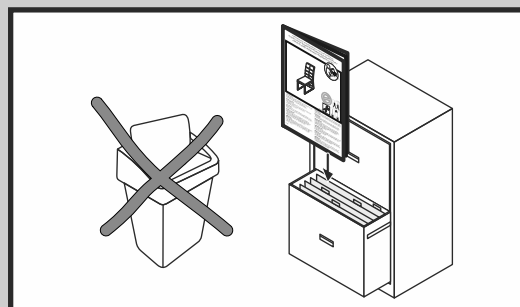

Colli 1

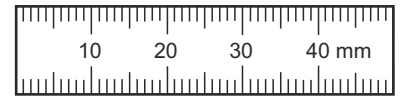
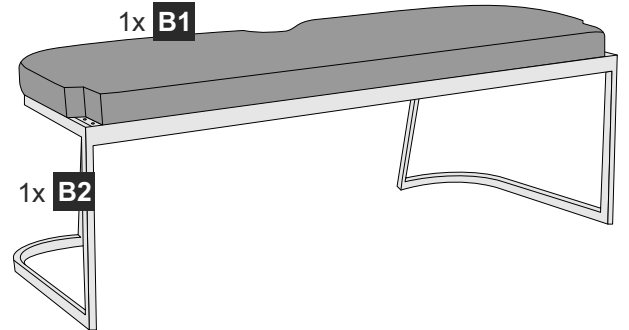
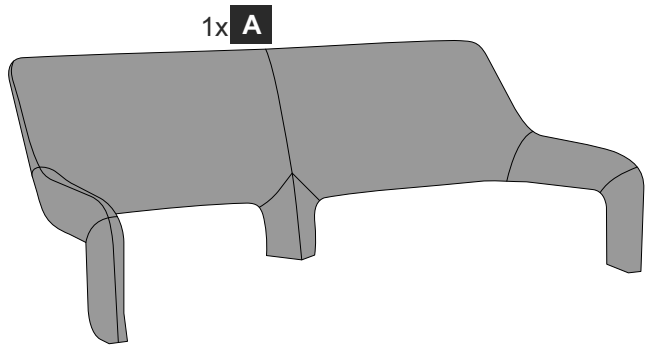

8x **S1**



M6 x 16

6x **S2**

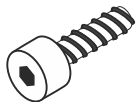

M8 x 25

8x **U1**



Ø 17 / 6 x 1,5

6x **U2**



Ø 17 / 8 x 1,5

1x **I1**

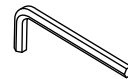

SW 4

1x **I2**

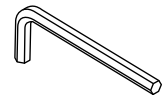

SW 6

Änderungen die der technischen Verbesserung dienen, behalten wir uns vor.
Subject to changes in the interests of technical improvements.

1.

B1 B2

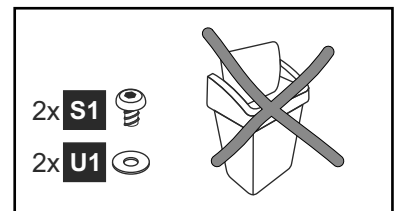
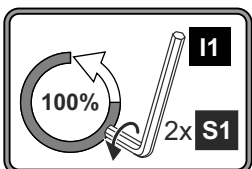
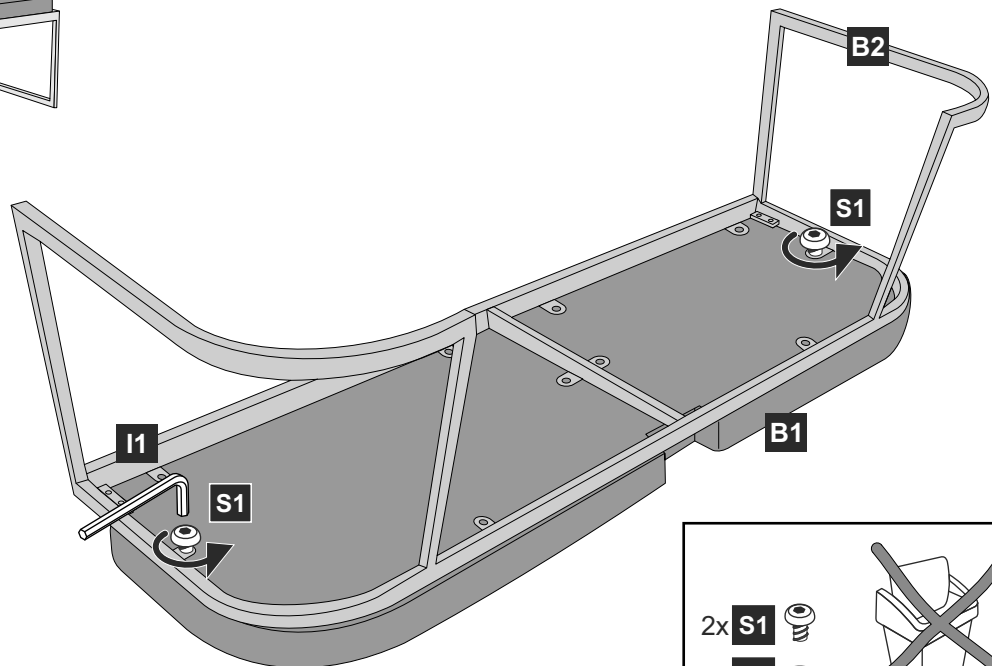
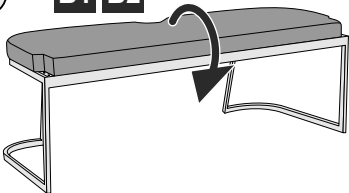

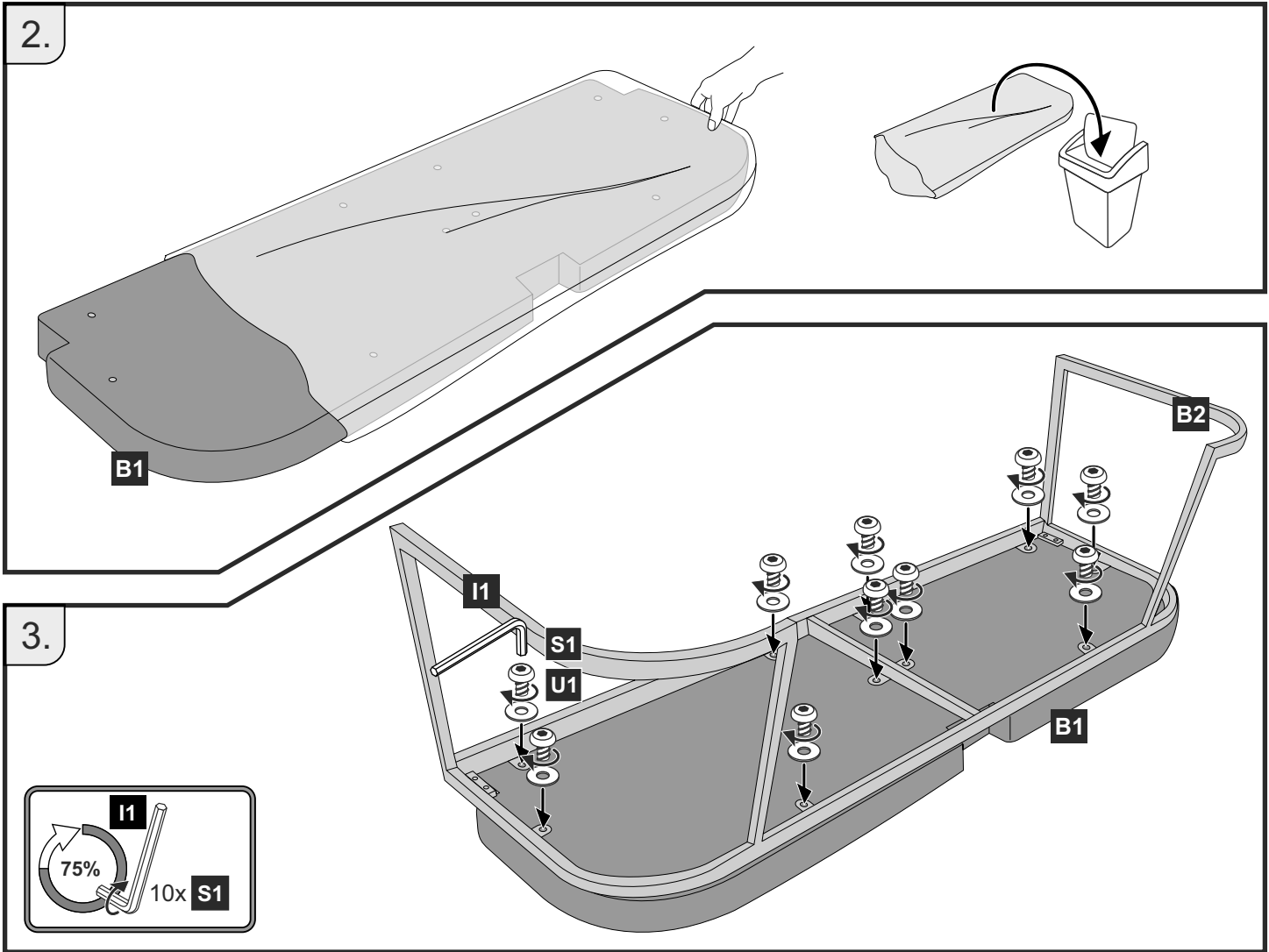

5.

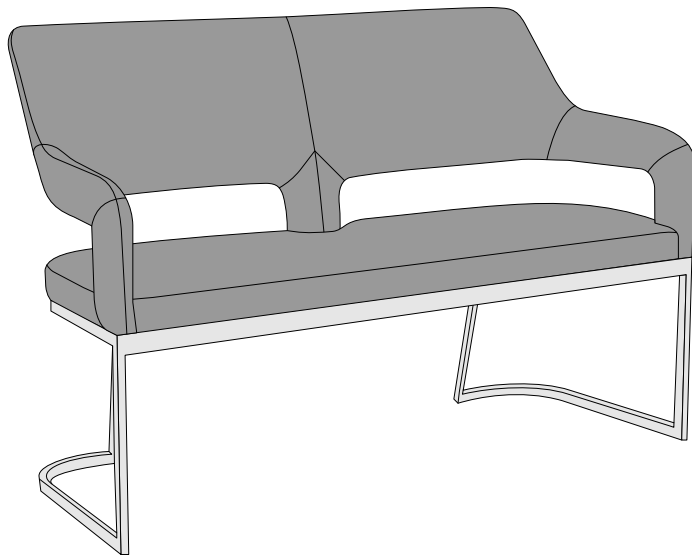
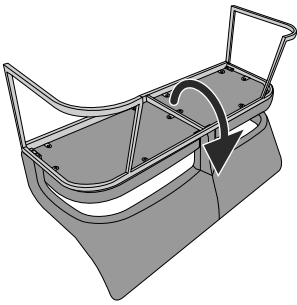
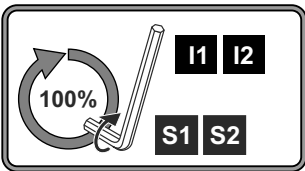
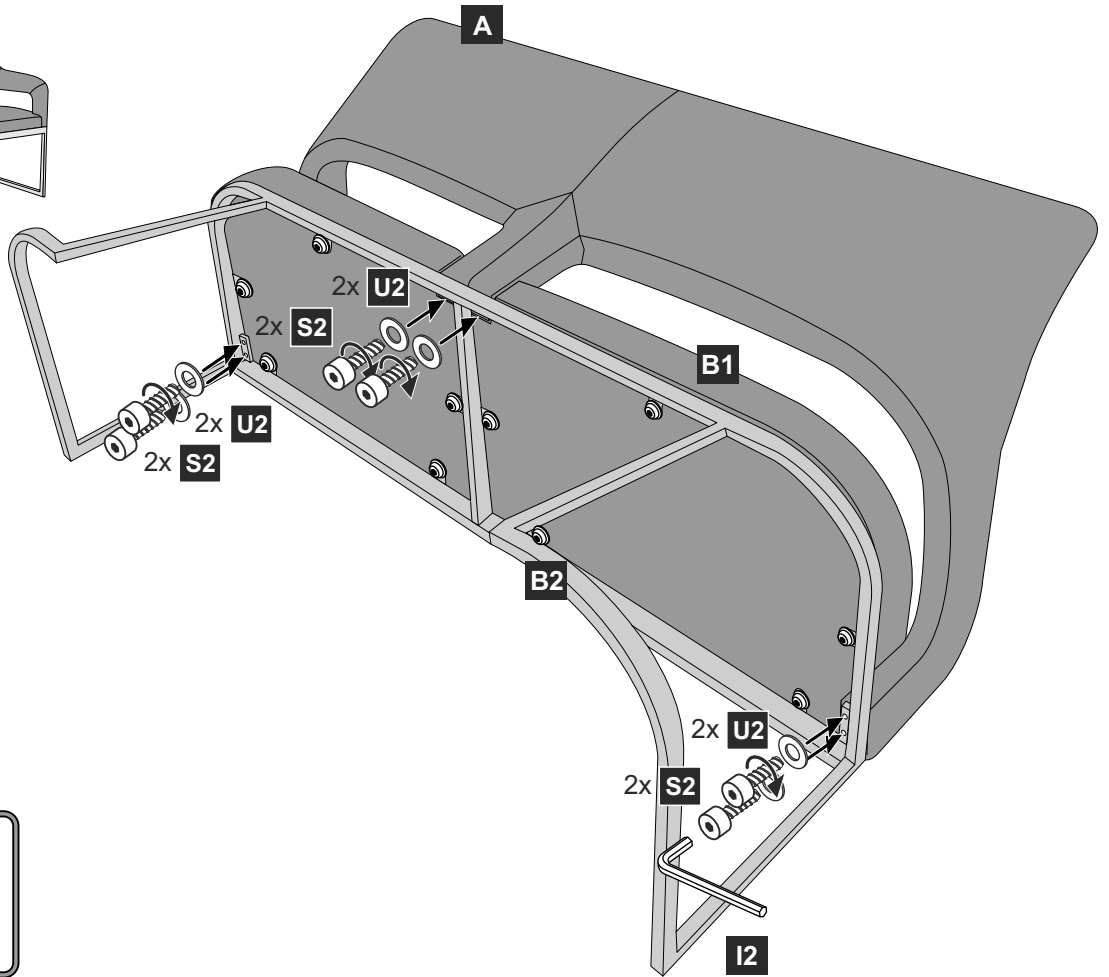
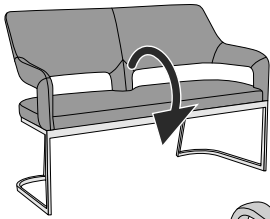

Max. 240 kg