



(D) Montageanleitung

(GB) Assembly instructions

(FR) Notice de montage

(TR) Montaj talimatı

(IT) Istruzioni di montaggio

(NL) Handleiding voor de montage

(RU) Инструкция по монтажу

(CZ) Montážní návod

(HU) Szerelési útmutató

(RO) Instrucțiuni de montaj

(PL) Instrukcja montażu

(SK) Návod na montáž

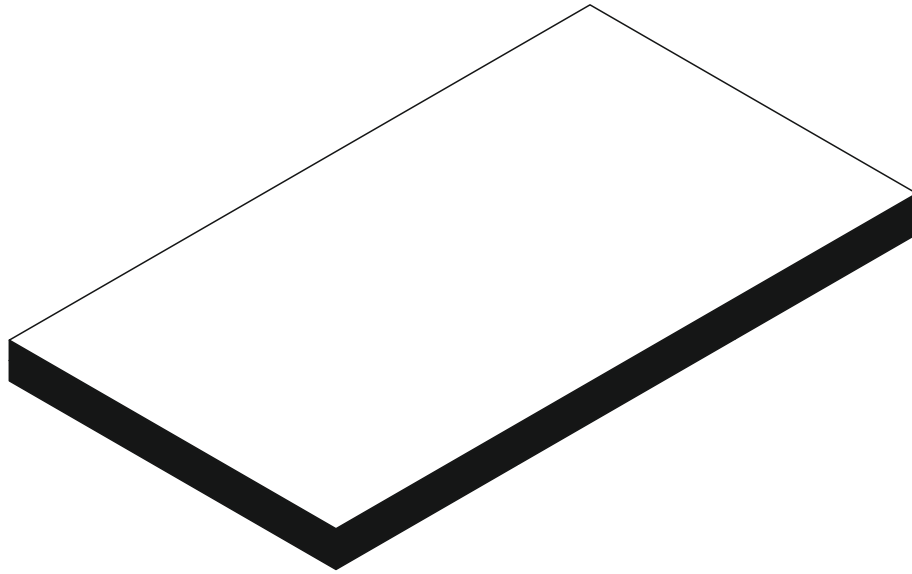





# 0780-TP\_160-260 Tischplatte

Service • Assistenza • Dienstverlening • Servis  
Servis • Szerviz • Сервисная служба

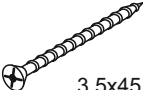
	<p>Colli 1/3: ① ② ④ ⑦ Colli 2/3: ③ ⑤ ⑥ Beutel 1/2</p>

## Beutel 1/2

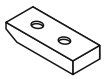
1-33		1-120		1-174		1-315		1-552		5-190	
52x	4x17	10x	3,5x45	12x	4,5x50	12x		4x	4x		
5-193											
6x											

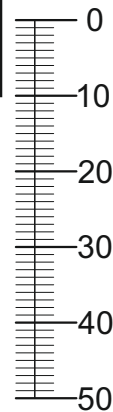

## Colli 1/3

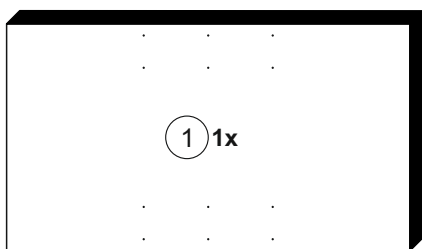

1600 x 900

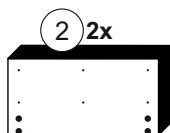

598 x 302

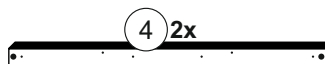

1258 x 68

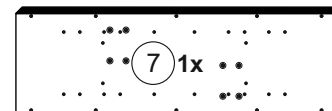

1258 x 394

## Colli 2/3

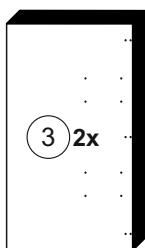

900 x 500

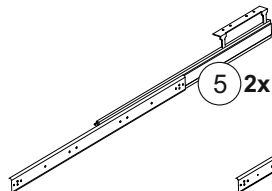

1258 x 68

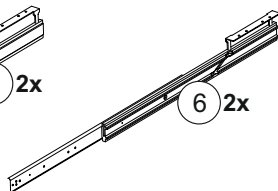

1258 x 68

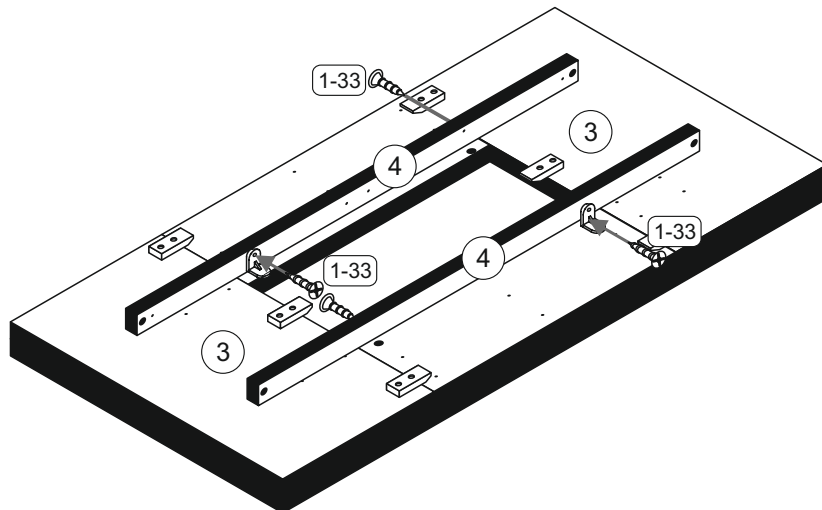
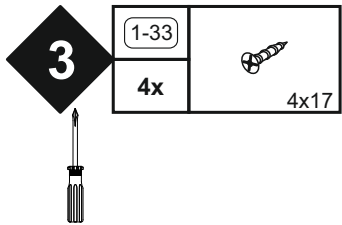
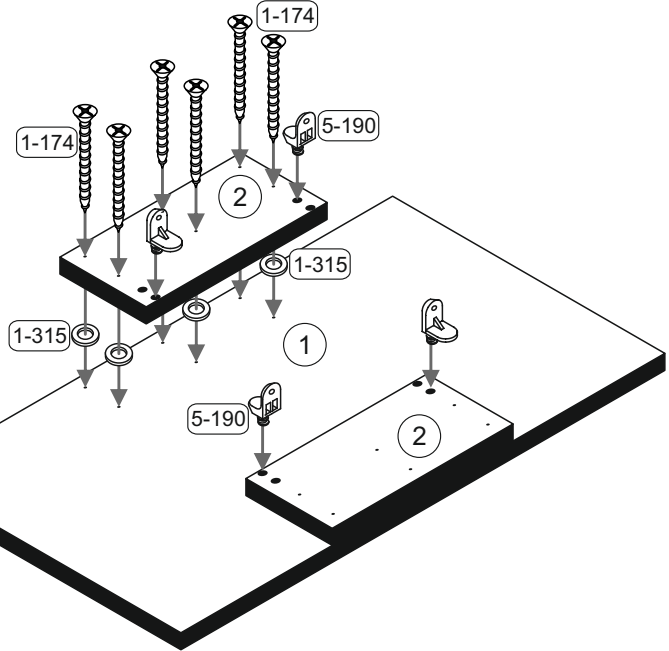
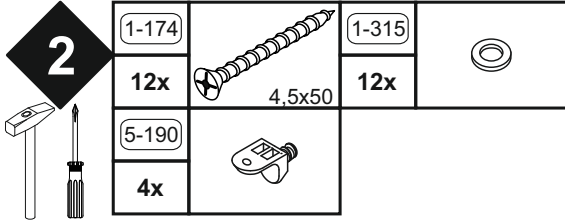
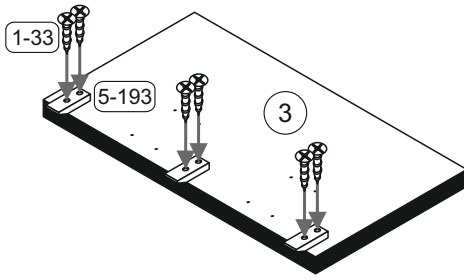
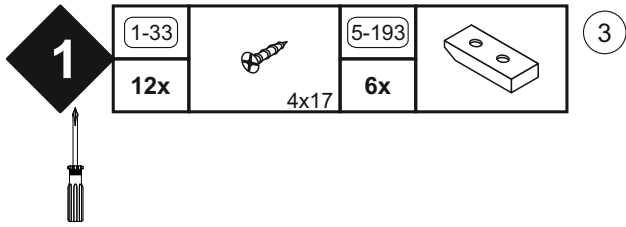

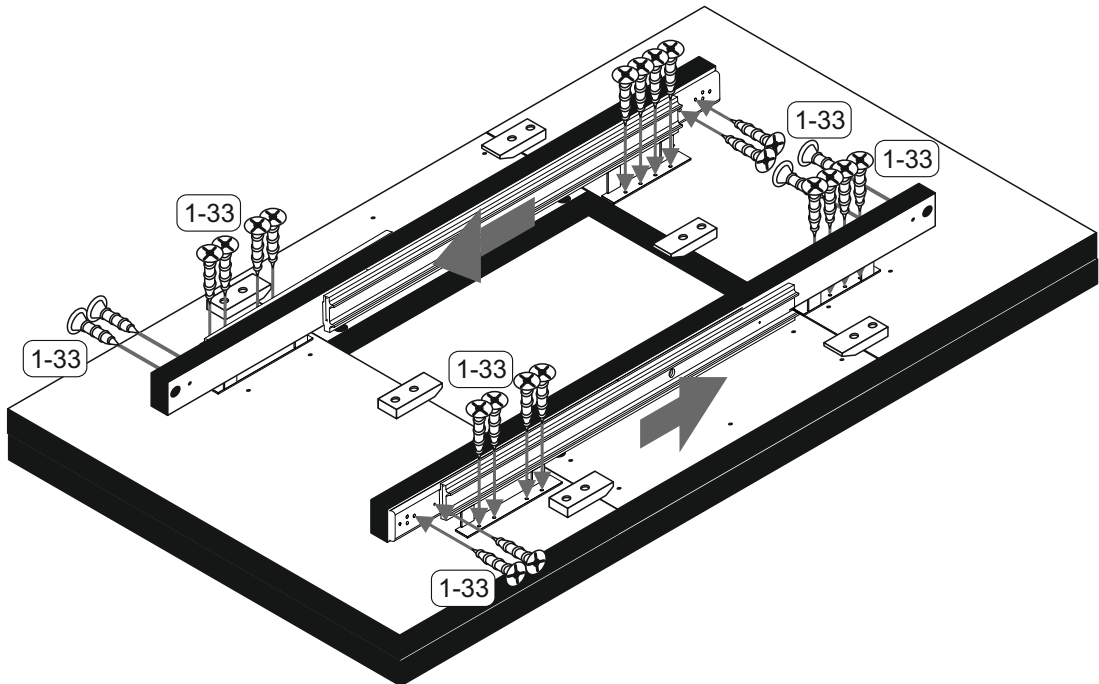
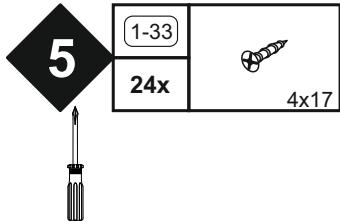
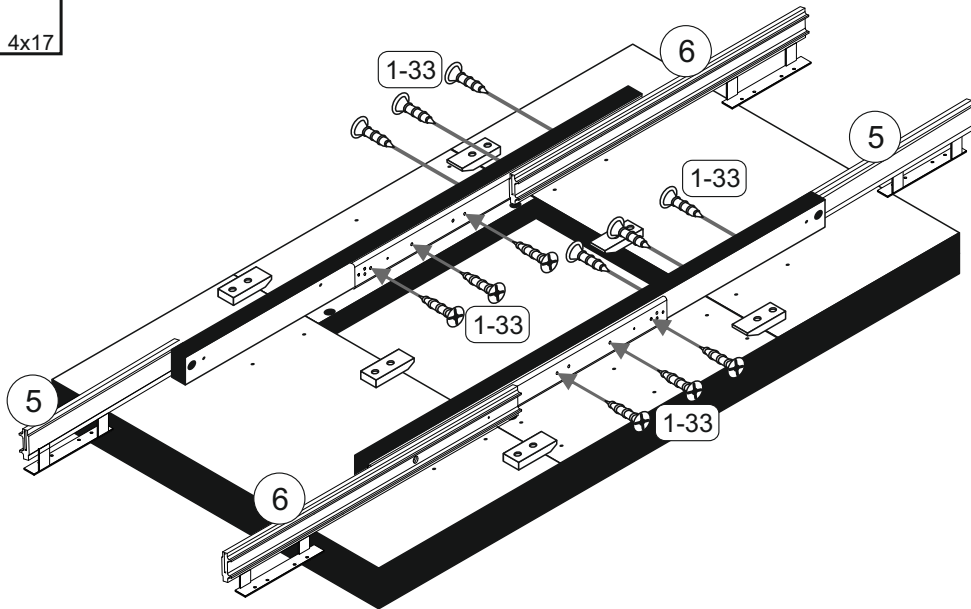
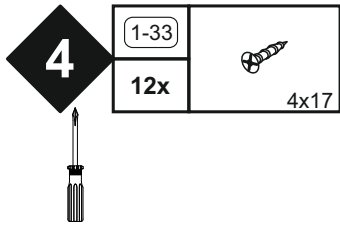



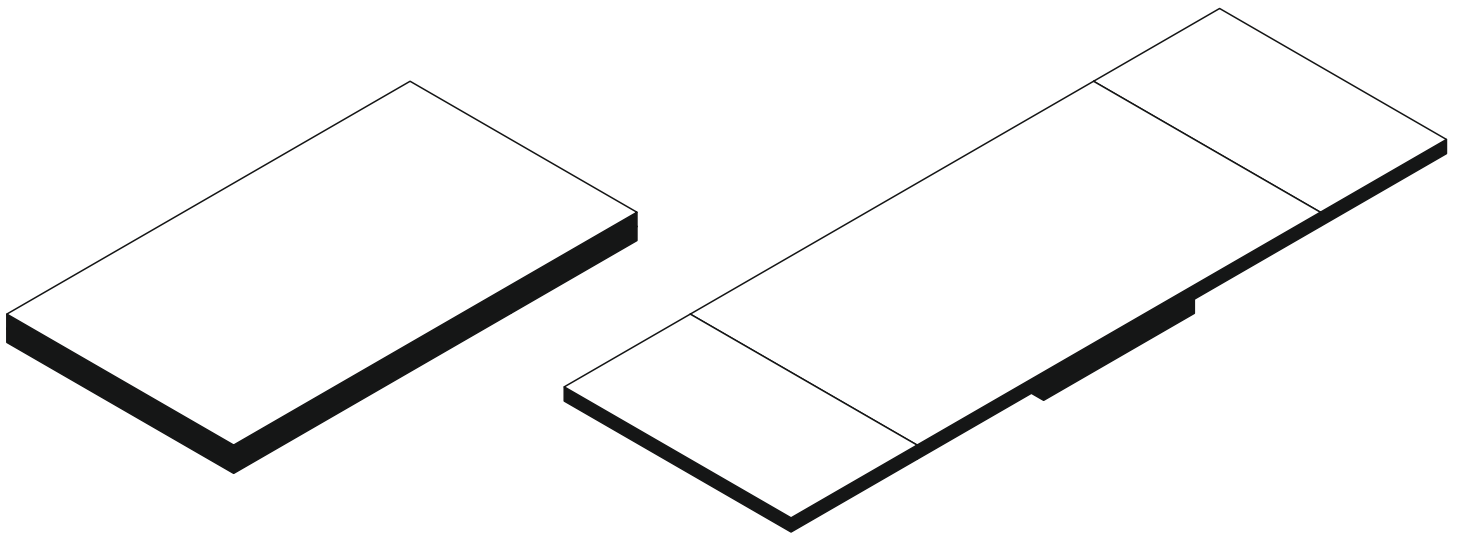

**Die Montage der Mittelplatte 7 wird bei der Montage des Fußes dargestellt.**

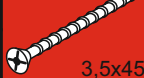
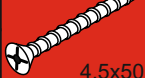

## Beutel 1/2

1-33		1-120		1-174		1-315		1-552		5-190	
52x	4x17	10x	3,5x45	12x	4,5x50	12x		4x		4x	
5-193											
6x											

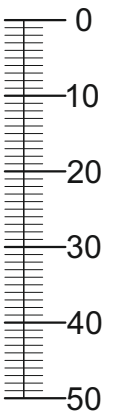

## Anleitung

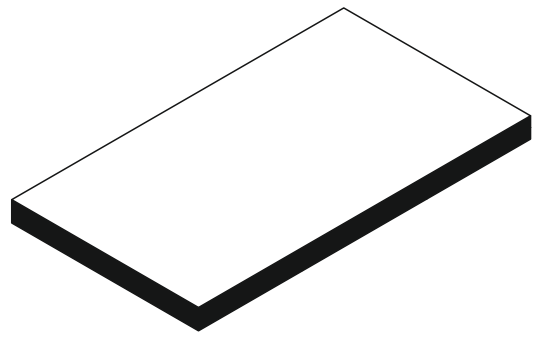

### Colli 1/3

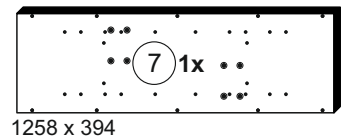
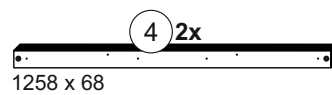
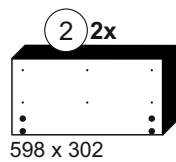
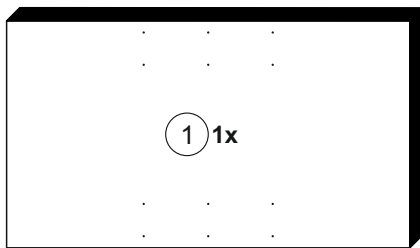

## 0780-TP\_160-260 Tischplatte

### Colli 2/3

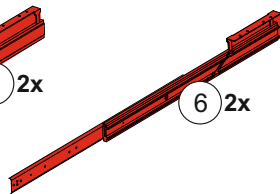
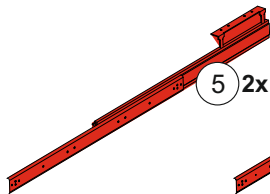
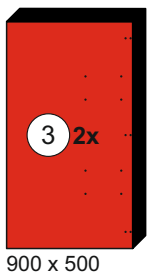

## Farbzuordnung Packstück Teilezuordnung



= Pack 1



= Pack 2



= Pack 3



= Pack 4

